



LOW VOLTAGE CABLES



MARK
CABLES FZE



www.markcables.com



Index

Introduction	03
Copper Conductor, PVC Insulated, PVC Sheathed Armoured Cables	05
Copper Conductor, XLPE Insulated, PVC Sheathed Armoured Cables	08
Copper Conductor, PVC Insulated, PVC Sheathed Unarmoured Cables	11
Aluminium Conductor, PVC Insulated, PVC Sheathed Unarmoured Cables	17
Copper Conductor, XLPE Insulated, PVC Sheathed Unarmoured Cables	21
Aluminium Conductor, XLPE Insulated, PVC Sheathed Unarmoured Cables	27
Copper Conductor, XLPE Insulated, LSZH Sheathed Unarmoured Cables	31
Aluminium Conductor, XLPE Insulated, LSZH Sheathed Unarmoured Cables	37
Copper Conductor, XLPE Insulated, LSZH Sheathed Armoured Cables	41
Electrical Parameters for LV Cables	44
Insulation and Sheathing Material Characteristics	47
Guidelines for the selection of the required size of cable	54
Drum Handling Instruction	55



Introduction

Mark Cables FZE is a Cable Manufacturer processing both Copper and Aluminium Rods as input raw material to produce wire and cable as finished product. We are located in Jebel Ali Freezone Dubai – UAE.

Mark Cables is privately owned with sister companies in Angola, Rwanda, South Africa where the group has interests in Wire & Cable, Steel Forming, Paints, Household plastic products manufacturing. Our partner companies are:

- Milbridge Holding SA (Secursal em Angola) (Steel Forming, Wire & Cable, Paints)
- Primeplast Lda – Angola – Plastic Products Manufacturing
- Afriprecast – Rwanda (Precast Concrete Solutions)
- Casasteel Pty Ltd – South Africa – Steel Products Trading Company

Our team is committed to providing our customers value by offering high levels of industry experience, superior customer service, and a large selection of quality cables in both copper and aluminium wires, building wires, flexible cables, control cables, low voltage power cables, overhead conductors and underground cables.

Vision, Mission & Core Values

Our Vision: To be a Leading Quality Manufacturer of Cables and Related Products in the Middle East and Africa.

Our Mission: We are committed to developing and improving manufacturing methods to ensure the highest possible level of value, quality and products to meet our clients' needs through being a responsible and dependable manufacturer

Our Core Values: Our corporate values center on four core elements explained below:

Ownership

- We trust our employees to make every effort to do right by the company, and we make every effort to do right by employees in return

Integrity

- We treasure loyalty, uphold honesty, and practice good business ethics.

Reliability

- We uphold service excellence, take pride in our product quality and ensure commitments are duly fulfilled and are consistently upheld.

Teamwork

- We embrace teamwork, harmony and mutual respect with our customers, suppliers, and employees

Company Quality Policy

Mark Cables FZE is committed to supplying products and services to its clients that fully satisfy their requirements and expectations. Quality permeates our entire process all the way from procurement of raw materials, production, quality testing, delivery and after sales backup services to the customer. Our products are manufactured to international standards. Our cables are individually tested in our laboratory to ensure that the products meet the highest standards. Certificates of Conformity are available upon request for each shipment.

The cables manufactured by Mark Cables FZE are clearly marked with the company name, cable size details and voltage ratings.

The management of Mark Cables are committed to implementing the following policy:-

- **Customers:** Provide products and services that comply with the requirements and expectations of our customers.
- **Owners:** Provide products that will deliver a profit to the organization without compromise to quality and the necessary resources for Organizational, Operational support management of the business.
- **Employees:** Provide a safe working environment; develop our team to improve our core competencies and their development and job satisfaction.
- **Suppliers:** Select our suppliers and partners fairly and without prejudice to our stakeholders.
- **Community:** Engage in charitable works for the benefit of our community and society.
- **Statutory/Regulatory Requirements:** Comply with applicable legal and statutory requirements

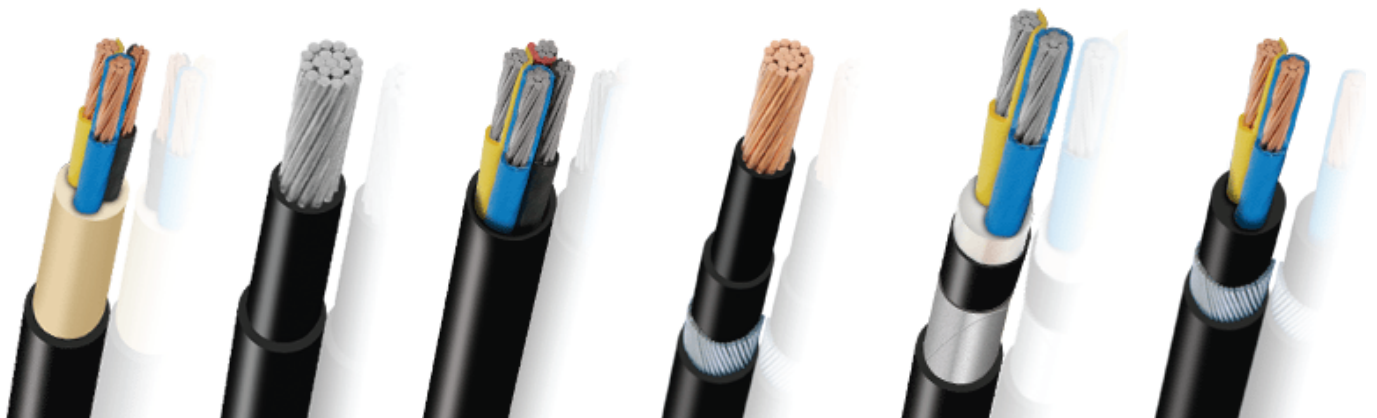

PVC INSULATED, PVC SHEATHED CABLES

COPPER CONDUCTOR STANDARD: BS 6346 0.6/1 kV



ALUMINIUM WIRE ARMoured CABLES

Nominal Area	No. of Wires	Approx. Conductor Diameter	Nominal Insulation Thickness	Nominal Alum/Steel Wire Dia.	Nominal Sheath Thickness	Approx. Overall Diameter	Approx. Weight	Standard Packing
mm ²	No.	mm	mm	mm	mm	mm	Kg/Km	meters
1x50 rmc	19	8.1	1.4	1.25	1.5	19	750	1000
1x70 rmc	19	9.7	1.4	1.25	1.6	21	1000	1000
1x95 rmc	19	11.4	1.6	1.25	1.6	23	1300	1000
1x120 rmc	37	12.9	1.6	1.6	1.7	26	1660	1000
1x150 rmc	37	14.3	1.8	1.6	1.7	28	1970	1000
1x185 rmc	37	16.0	2.0	1.6	1.8	30	2400	500
1x240 rmc	61	18.4	2.2	1.6	1.9	34	3025	500
1x300 rmc	61	20.4	2.4	1.6	1.9	37	3650	500
1x400 rmc	61	23.2	2.6	2.0	2.1	42	4675	500
1x500 rmc	61	26.7	2.8	2.0	2.1	46	5825	500
1x630 rmc	91	30.4	2.8	2.0	2.2	49	7275	500
1x800 rmc	91	33.7	2.8	2.5	2.4	56	9275	500
1x1000 rm	91	41.0	3.0	2.5	2.5	61	11800	250

STEEL WIRE ARMoured CABLES

2x1.5 rm	7	1.56	0.6	0.9	1.4	12.5	325	1000
2x2.5 rm	7	2.01	0.7	0.9	1.4	14	400	1000
2x4 rm	7	2.55	0.8	0.9	1.4	15	450	1000
2x6 rm	7	3.1	0.8	0.9	1.5	17	540	1000
2x10 rm	7	4.0	1.0	1.25	1.6	20	850	1000
2x16 rm	7	5.0	1.0	1.25	1.6	22	1070	1000
2x25 sm	7	-	1.2	1.6	1.7	23	1345	1000
2x35 sm	7	-	1.2	1.6	1.8	25	1615	1000
2x50 sm	19	-	1.4	1.6	1.9	28	2010	500
2x70 sm	19	-	1.4	1.6	1.9	30	2510	500
2x95 sm	19	-	1.6	2.0	2.1	35.5	3490	500
2x120 sm	37	-	1.6	2.0	2.2	38	4100	500
2x150 sm	37	-	1.8	2.0	2.3	41	4840	500
2x185 sm	37	-	2.0	2.5	2.4	46	6230	250
2x240 sm	61	-	2.2	2.5	2.5	51	7660	250
2x300 sm	61	-	2.4	2.5	2.7	56	9250	250

rm : Round Stranded
 rmc : Round Stranded Compacted
 sm : Sectoral Stranded

Standard Colour Code:
 1 Core : Black (Red on request)
 2 Cores : Red, Black

Color Code based on special request.
 1 Core : Brown or Blue
 2 Cores : Brown, Blue

PVC INSULATED, PVC SHEATHED CABLES

COPPER CONDUCTOR STANDARD: BS 6346

0.6 /1 kV

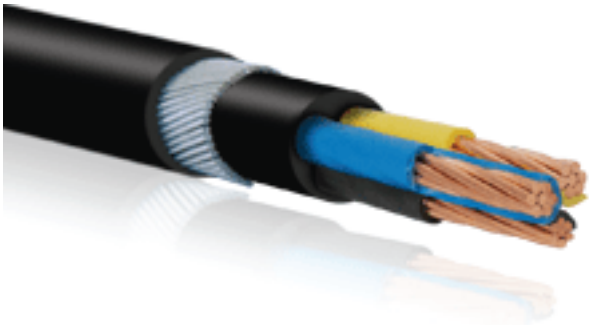

STEEL WIRE ARMoured CABLES

Nominal Area	No. of Wires	Approx. Conductor Diameter	Nominal Insulation Thickness	Nominal Alum/Steel Wire Dia.	Nominal Sheath Thickness	Approx. Overall Diameter	Approx. Weight	Standard Packing
mm ²	No.	mm	mm	mm	mm	mm	Kg/Km	meters
3x1.5 rm	7	1.56	0.6	0.9	1.4	13	320	1000
3x2.5 rm	7	2.01	0.7	0.9	1.4	14	400	1000
3x4 rm	7	2.55	0.8	0.9	1.4	16	500	1000
3x6 rm	7	3.12	0.8	1.25	1.5	18	720	1000
3x10 rm	7	4.01	1.0	1.25	1.6	21	960	1000
3x16 rm	7	5.03	1.0	1.25	1.6	23	1220	1000
3x25 sm	7	-	1.2	1.6	1.7	25	1720	1000
3x35 sm	7	-	1.2	1.6	1.8	27	2100	1000
3x50 sm	19	-	1.4	1.6	1.9	31	2665	1000
3x70 sm	19	-	1.4	2.0	2.0	35	3690	500
3x95 sm	19	-	1.6	2.0	2.1	39	4710	500
3x120 sm	37	-	1.6	2.0	2.2	42	5570	500
3x150 sm	37	-	1.8	2.5	2.4	48	7135	500
3x185 sm	37	-	2.0	2.5	2.5	52	8500	250
3x240 sm	61	-	2.2	2.5	2.6	58	10610	250
3x300 sm	61	-	2.4	2.5	2.8	64	12810	250
3x400 sm	61	-	2.6	2.5	3.0	70	15790	250

rm : Round Stranded
sm : Sectoral Stranded

Standard Colour Code:
3 core: Red, Yellow, Blue

Color Code based on special request.
3 Cores: Green / Yellow, Blue, Brown

PVC INSULATED, PVC SHEATHED CABLES

COPPER CONDUCTOR STANDARD:BS 6346

0.6/1 kV



STEEL WIRE ARMoured CABLES

Nominal Area	No. of Wires	Approx. Conductor Diameter	Nominal Insulation Thickness	Nominal Alum/Steel Wire Dia.	Nominal Sheath Thickness	Approx. Overall Diameter	Approx. Weight	Standard Packing
mm ²	No.	mm	mm	mm	mm	mm	Kg/Km	meters
4x1.5 rm	7	1.56	0.6	0.9	1.4	13	360	1000
4x2.5 rm	7	2.01	0.7	0.9	1.4	14	460	1000
4x4 rm	7	2.55	0.8	1.25	1.5	17	700	1000
4x6 rm	7	3.12	0.8	1.25	1.5	19	830	1000
4x10 rm	7	4.01	1.0	1.25	1.6	22	1120	1000
4x16 rm	7	5.03	1.0	1.6	1.7	26	1700	1000
4x25 sm	7	-	1.2	1.6	1.8	28	2110	1000
4x35 sm	7	-	1.2	1.6	1.9	31	2590	1000
4x50 sm	19	-	1.4	2.0	2.0	36	3600	500
4x70 sm	19	-	1.4	2.0	2.1	40	4560	500
4x95 sm	19	-	1.6	2.0	2.2	44	5900	500
4x120sm	37	-	1.6	2.5	2.4	49	7500	500
4x150 sm	37	-	1.8	2.5	2.5	54	8900	250
4x185 sm	37	-	2.0	2.5	2.6	59	10770	250
4x240 sm	61	-	2.2	2.5	2.8	65	13490	250
4x300 sm	61	-	2.4	2.5	3.0	71	16320	250
4x400 sm	61	-	2.6	3.15	3.3	82	21250	250

STEEL WIRE ARMoured CABLES

5x1.5 rm	7	1.56	0.9	0.9	1.4	14	400	1000
5x2.5 rm	7	2.01	0.7	0.9	1.5	16	540	1000
5x4 rm	7	2.55	0.8	1.25	1.5	18	800	1000
5x6 rm	7	3.12	0.8	1.25	1.6	20	970	1000
5x10 rm	7	4.01	1.0	1.6	1.7	25	1510	1000
5x16 rm	7	5.03	1.0	1.6	1.7	28	1940	1000
5x25 rm	7	6.3	1.2	1.6	1.9	33	2690	500
5x35 rm	7	7.44	1.2	1.6	1.9	36	3320	500
5x50 rmc	19	8.10	1.4	2.0	2.1	41	4400	500
5x70 rmc	19	9.70	1.4	2.0	2.2	45	5670	500

rm : Round Stranded
 rmc : Round Stranded Compacted
 sm : Sectoral Stranded

Standard Colour Code:
 4 cores: Red, Yellow, Blue, Black
 5 cores: Red, Yellow, Blue, Black, Green/Yellow

Color Code based on special request.
 4 cores: Blue, Brown, Black, Grey
 5 cores: Green/Yellow, Blue, Brown, Black, Grey

XIPE INSULATED, PVC SHEATHED CABLES

COPPER CONDUCTOR STANDARD:BS 5467

0.6/1 kV



ALUMINIUM WIRE ARMoured CABLES

Nominal Area	No. of Wires	Approx. Conductor Diameter	Nominal Insulation Thickness	Nominal Alum/Steel Wire Dia.	Nominal Sheath Thickness	Approx. Overall Diameter	Approx. Weight	Standard Packing
mm ²	No.	mm	mm	mm	mm	mm	Kg/Km	meters
1x50 rmc	19	8.1	1.0	0.9	1.5	17	700	1000
1x70 rmc	19	9.7	1.1	1.25	1.5	20	925	1000
1x95 rmc	19 1	1.4	1.1	1.25	1.6	22	1200	1000
1x120 rmc	37	12.9	1.2	1.25	1.6	24	1450	1000
1x150 rmc	37	14.3	1.4	1.6	1.7	27	1850	1000
1x185 rmc	37	16.0	1.6	1.6	1.8	30	2250	1000
1x240 rmc	61	18.4	1.7.	1.6	1.8	32	2850	500
1x300 rmc	61	20.4	1.8	1.6	1.9	35	3475	500
1x400 rmc	61	23.2	2.0	2.0	2.0	40	4470	500
1x500 rmc	61	26.7	2.2	2.0	2.1	44	5575	500
1x630 rmc	61	30.4	2.4	2.0	2.2	49	7050	500
1x800 rmc	61	33.7	2.6	2.5	2.4	55	9050	500
1x1000 rmc	91	41.0	2.8	2.5	2.5	60	11500	250

STEEL WIRE ARMoured CABLES

2x1.5 rm	7	1.56	0.6	0.9	1.3	12	280	1000
2x2.5 rm	7	2.01	0.7	0.9	1.4	14	350	1000
2x4 rm	7	2.55	0.7	0.9	1.4	15	425	1000
2x6 rm	7	3.12	0.7	0.9	1.4	16	500	1000
2x10 rm	7	4.01	0.7	0.9	1.5	18	655	1000
2x16 rm	7	5.03	0.7	1.25	1.5	20	970	1000
2x25 sm	7	-	0.9	1.25	1.6	24	1350	1000
2x35 sm	7	-	0.9	1.6	1.7	27	1850	1000

rm : Round Stranded

rmc : Round Stranded Compacted

sm : Sectoral Stranded

Standard Colour Code:

1 Core : Black (Red on request)

2 Cores : Red, Black

Color Code based on special request.

1 Core : Brown or Blue

2 Cores : Brown, Blue

XLPE INSULATED, PVC SHEATHED CABLES

COPPER CONDUCTOR STANDARD:BS 5467

0.6/1 kV



STEEL WIRE ARMoured CABLES

Nominal Area	No. of Wires	Approx. Conductor Diameter	Nominal Insulation Thickness	Nominal Alum/Steel Wire Dia.	Nominal Sheath Thickness	Approx. Overall Diameter	Approx. Weight	Standard Packing
mm ²	No.	mm	mm	mm	mm	mm	Kg/Km	meters
3x1.5 rm	7	1.56	0.6	0.9	1.3	13	300	1000
3x2.5 rm	7	2.01	0.7	0.9	1.4	14	390	1000
3x4 rm	7	2.55	0.7	0.9	1.4	15	475	1000
3x6 rm	7	3.12	0.7	0.9	1.4	17	575	1000
3x10 rm	7	4.01	0.7	1.25	1.5	20	850	1000
3x16 rm	7	5.03	0.7	1.25	1.6	22	1110	1000
3x25 sm	7	-	0.9	1.6	1.7	24	1590	1000
3x35 sm	7	-	0.9	1.6	1.8	26	1965	1000
3x50 sm	19	-	1.0	1.6	1.8	29	2440	500
3x70 sm	19	-	1.1	1.6	1.9	32	3200	500
3X95 sm	19	-	1.1	2.0	2.1	37	4390	500
3x120 sm	37	-	1.2	2.0	2.2	41	5250	500
3x150 sm	37	-	1.4	2.5	2.3	46	6740	250
3x185 sm	37	-	1.6	2.5	2.4	50	8050	250
3x240 sm	61	-	1.7	2.5	2.6	55	9990	250
3x300 sm	61	-	1.8	2.5	2.7	60	12100	250
3x400 sm	61	-	2.0	2.5	2.9	67	14970	250

rm : Round Stranded
sm : Sectoral Stranded

Standard Colour Code:
3 cores : Red, Yellow, Blue

Color Code based on special request.
3 cores : Green / Yellow, Blue, Brown

XLPE INSULATED, PVC SHEATHED CABLES

COPPER CONDUCTOR STANDARD: BS 5467

0.6/1 kV

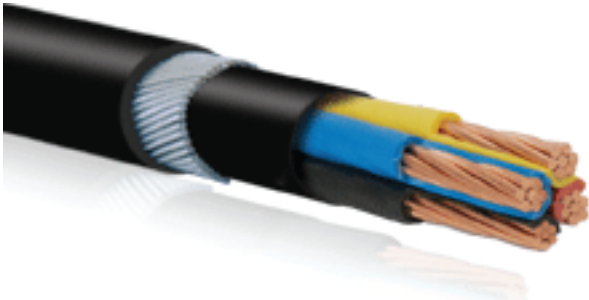

STEEL WIRE ARMoured CABLES

Nominal Area	No. of Wires	Approx. Conductor Diameter	Nominal Insulation Thickness	Nominal Alum/Steel Wire Dia.	Nominal Sheath Thickness	Approx. Overall Diameter	Approx. Weight	Standard Packing
mm ²	No.	mm	mm	mm	mm	mm	Kg/Km	meters
4x1.5 rm	7	1.56	0.6	0.9	1.3	13	350	1000
4x2.5 rm	7	2.01	0.7	0.9	1.4	15	450	1000
4x4 rm	7	2.55	0.7	0.9	1.4	16	550	1000
4x6 rm	7	3.12	0.7	1.25	1.5	19	775	1000
4x10 rm	7	4.01	0.7	1.25	1.5	21	1000	1000
4x16 rm	7	5.03	0.7	1.25	1.6	23	1325	1000
4x25 sm	7	-	0.9	1.6	1.7	26	1925	1000
4x35 sm	7	-	0.9	1.6	1.8	29	2390	1000
4x50 sm	19	-	1.0	1.6	1.9	32	3015	500
4x70 sm	19	-	1.1	2.0	2.1	38	4300	500
4X95 sm	19	-	1.1	2.0	2.2	42	5500	500
4x120sm	37	-	1.2	2.5	2.3	47	7035	500
4x150 sm	37	-	1.4	2.5	2.4	52	8410	500
4x185 sm	37	-	1.6	2.5	2.6	57	10150	250
4x240 sm	61	-	1.7	2.5	2.7	63	12750	250
4x300 sm	61	-	1.8	2.5	2.9	69	15440	250
4x400 sm	61	-	2.0	3.15	3.2	78	20210	250

STEEL WIRE ARMoured CABLES

5x1.5 rm	7	1.56	0.6	0.9	1.4	14	400	1000
5x2.5 rm	7	2.01	0.7	0.9	1.4	16	515	1000
5x4 rm	7	2.55	0.7	0.9	1.5	18	650	1000
5x6 rm	7	3.12	0.7	1.25	1.5	20	900	1000
5x10 rm	7	4.01	0.7	1.25	1.6	23	1190	1000
5x16 rm	7	5.03	0.7	1.6	1.7	27	1775	1000
5x25 rm	7	6.3	0.9	1.6	1.8	31	2450	1000
5x35 rm	7	7.44	0.9	1.6	1.9	35	3075	500
5x50 rmc	19	8.1	1.0	2.0	2.0	40	4040	500
5x70 rmc	19	9.7	1.1	2.0	2.2	46	5355	500

rm: Round Stranded

rmc: Round Stranded Compacted

sm: Sectoral Stranded

Standard Colour Code:

4 cores: Red, Yellow, Blue, Black

5 cores: Red, Yellow, Blue, Black, Green/Yellow

Color Code based on special request.

4 Cores: Blue, Brown, Black, Grey

5 Cores: Green/Yellow, Blue, Brown, Black, Grey

PVC INSULATED, PVC SHEATHED CABLES

COPPER CONDUCTOR STANDARD:IEC 60502-1

0.6/1 kV



CABLE CORE(S)

Nominal Area	No. of Wires	Approx. Conductor Diameter	Nominal Insulation Thickness
mm ²	No.	mm	mm
1 x 1.5 re	1	1.38	0.8
1 x 1.5 rm	7	1.56	0.8
1 x 2.5 re	1	1.78	0.8
1 x 2.5 rm	7	2.01	0.8
1 x 4 re	1	2.25	1.0
1 x 4 rm	7	2.55	1.0
1 x 6 re	1	2.76	1.0
1 x 6 rm	7	3.12	1.0
1 x 10 re	7	3.57	1.0
1 x 10 rm	7	4.01	1.0
1 x 16 rm	7	5.03	1.0
1 x 25 rm	7	6.3	1.2
1 x 35 rm	7	7.44	1.2
1 x 50 rmc	19	8.1	1.4
1 x 70 rmc	19	9.7	1.4
1 x 95 rmc	19	11.4	1.6
1 x 120 rmc	37	12.9	1.6
1 x 150 rmc	37	14.3	1.8
1 x 185 rmc	37	16.0	2.0
1 x 240 rmc	61	18.4	2.2
1 x 300 rmc	61	20.4	2.4
1 x 400 rmc	61	23.2	2.6
1 x 500 rmc	61	26.7	2.8
1 x 630 rmc	61	30.4	2.8
1 x 800 rmc	61	33.7	2.8
1 x 1000 rm	91	41.0	3.0

UNARMoured

Nominal Sheath Thickness	Approx. Overall Diameter	Approx. Weight	Standard Packing
mm	mm	mm	Kg/Km
1.4	6	55	1000
1.4	6	55	1000
1.4	7	65	1000
1.4	7	70	1000
1.4	7	90	1000
1.4	8	95	1000
1.4	8	110	1000
1.4	8	120	1000
1.4	9	155	1000
1.4	9	165	1000
1.4	10	230	1000
1.4	12	335	1000
1.4	13	440	1000
1.4	14	550	1000
1.4	15	760	1000
1.5	18	1040	1000
1.5	19	1275	1000
1.6	21	1565	1000
1.7	24	1950	1000
1.7	27	2540	1000
1.8	29	3160	1000
1.9	33	4000	500
2.1	37	5070	500
2.2	40	6470	500
2.3	44	8150	250
2.5	52	10530	250

CABLE CORE(S)

2 x 1.5 re	1	1.38	0.8
2 x 1.5 rm	7	1.56	0.8
2 x 2.5 re	1	1.78	0.8
2 x 2.5 rm	7	2.01	0.8
2 x 4 re	1	2.25	1.0
2 x 4 rm	7	2.55	1.0
2 x 6 re	1	2.76	1.0
2 x 6 rm	7	3.12	1.0
2 x 10 re	1	3.57	1.0
2 x 10 rm	7	4.01	1.0
2 x 16 rm	7	5.03	1.0
2 x 25 sm	7	-	1.2
2 x 35 sm	7	-	1.2
2 x 50 sm	19	-	1.4
2 x 70 sm	19	-	1.4
2 x 95 sm	19	-	1.6
2 x 120 sm	37	-	1.6
2 x 150 sm	37	-	1.8
2 x 185 sm	37	-	2.0
2 x 240 sm	61	-	2.2
2 x 300 sm	61	-	2.4

UNARMoured

1.8	12	200	1000
1.8	12	200	1000
1.8	13	225	1000
1.8	13	250	1000
1.8	15	325	1000
1.8	15	325	1000
1.8	16	375	1000
1.8	16	400	1000
1.8	18	500	1000
1.8	18	525	1000
1.8	20	700	1000
1.8	21	790	1000
1.8	22	1000	1000
1.8	25	1300	1000
1.9	28	1735	1000
2.0	32	2350	500
2.1	34	2855	500
2.2	38	3480	500
2.4	41	4360	500
2.6	46	5600	250
2.7	57	6960	250

re : Round Solid
 rm : Round Stranded 1
 sm : Sectoral Stranded
 rmc : Round Stranded Compacted

Colour Code:
 Core: Black (red on request)
 2 Cores: Red, Black

Tolerance range:
 Overall diameter ± 5%
 Packing ± 5%

PVC INSULATED, PVC SHEATHED CABLES

COPPER CONDUCTOR STANDARD: IEC 60502-1

0.6/1 kV

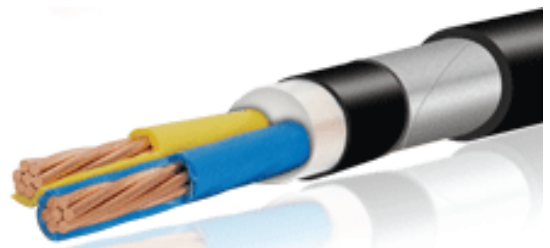

ALUMINIUM WIRE ARMoured

Nominal Alum./Steel Wire diameter	Nominal Sheath Thickness	Approx. Overall diameter	Approx. Weight Kg/Km	Standard Packing meters
-	-	-	-	-
0.8	1.8	11	150	-
-	-	-	-	-
0.8	1.8	12	175	-
-	-	-	-	-
0.8	1.8	13	200	-
-	-	-	-	-
0.8	1.8	13	250	-
-	-	-	-	-
0.8	1.8	14	300	1000
0.8	1.8	15	375	1000
0.8	1.8	17	500	1000
0.8	1.8	18	625	1000
1.25	1.8	20	800	1000
1.25	1.8	21	1025	1000
1.25	1.8	24	1325	1000
1.6	1.8	26	1650	1000
1.6	1.8	28	1950	1000
1.6	1.8	30	2375	500
1.6	1.9	33	3000	500
2.0	2.0	36	3750	500
2.0	2.1	40	4700	500
2.0	2.2	43	5850	500
2.0	2.4	48	7325	500
2.5	2.5	53	9300	250
2.5	2.7	61	11875	250

ALUMINIUM TAPE ARMoured

Aluminium / Steel Tape Thickness	Nominal Sheath Thickness	Approx. Overall diameter	Approx. Weight Kg/Km	Standard Packing meters
-	-	-	-	-
-	-	-	-	-
-	-	-	-	-
-	-	-	-	-
-	-	-	-	-
-	-	-	-	-
-	-	-	-	-
-	-	-	-	-
0.5	1.8	14	300	1000
0.5	1.8	15	380	1000
0.5	1.8	17	500	1000
0.5	1.8	18	625	1000
0.5	1.8	19	775	1000
0.5	1.8	20	980	1000
0.5	1.8	22	1275	1000
0.5	1.8	23	1530	1000
0.5	1.8	26	1830	1000
0.5	1.8	28	2230	1000
0.5	1.9	30	2850	500
0.5	1.9	33	3480	500
0.5	2.1	37	4410	500
0.5	2.2	41	5550	500
0.5	2.3	45	6980	500
-	-	-	-	-
-	-	-	-	-

STEEL WIRE ARMoured

-	-	-	-	-
-	1.8	14	350	1000
-	-	-	-	-
0.8	1.8	15	400	1000
0.8	1.8	17	515	1000
0.8	1.8	17	525	1000
0.8	1.8	19	730	1000
1.25	1.8	19	750	1000
1.25	1.8	20	825	1000
1.25	1.8	21	900	1000
1.25	1.8	23	1120	1000
1.6	1.8	24	1360	1000
1.6	1.8	26	1620	1000
1.6	1.9	28	2010	500
2.0	2.0	32	2740	500
2.0	2.2	36	3510	500
2.0	2.3	38	4120	500
2.5	2.4	43	5230	500
2.5	2.6	47	6280	250
2.5	2.8	52	7740	250
2.5	2.9	56	9310	250

STEEL TAPE ARMoured

-	-	-	-	-
0.2	1.8	13	270	1000
-	-	-	-	-
0.2	1.8	14	320	1000
0.2	1.8	15	400	1000
0.2	1.8	16	420	1000
0.2	1.8	17	460	1000
0.2	1.8	17	500	1000
0.2	1.8	18	600	1000
0.2	1.8	19	640	1000
0.2	1.8	21	830	1000
0.2	1.8	22	910	1000
0.2	1.8	23	1130	1000
0.2	1.8	26	1440	1000
0.2	1.9	28	1900	1000
0.2	2.0	32	2540	500
0.5	2.2	36	3400	500
0.5	2.3	40	4080	500
0.5	2.4	43	4990	500
0.5	2.6	49	6310	250
0.5	2.8	53	7770	250

PVC INSULATED, PVC SHEATHED CABLES

COPPER CONDUCTOR STANDARD: IEC 60502-1

0.6/1 kV



CABLE CORE(S)

Nominal Area	No. of Wires	Approx. Conductor Diameter	Nominal Insulation Thickness
mm ²	No.	mm	mm
3 x 1.5 re	1	1.38	0.8
3 x 1.5 rm	7	1.56	0.8
3 x 2.5 re	1	1.78	0.8
3 x 2.5 rm	7	2.01	0.8
3 x 4 re	1	2.25	1.0
3 x 4 rm	7	2.55	1.0
3 x 6 re	1	2.76	1.0
3 x 6 rm	7	3.12	1.0
3 x 10 re	1	3.57	1.0
3 x 10 rm	7	4.01	1.0
3 x 16 rm	7	5.03	1.0
3 x 25 sm	7	-	1.2
3 x 35 sm	7	-	1.2
3 x 50 sm	19	-	1.4
3 x 70 sm	19	-	1.4
3 x 95 sm	19	-	1.6
3 x 120 sm	37	-	1.6
3 x 150 sm	37	-	1.8
3 x 185 sm	37	-	2.0
3 x 240 sm	61	-	2.2
3 x 300 sm	61	-	2.4
3 x 400 sm	61	-	2.6
3 x 500 sm	61	-	2.8

UNARMoured

Nominal Sheath Thickness	Approx. Overall Diameter	Approx. Weight	Standard Packing
mm	mm	Kg/Km	meters
1.8	13	225	1000
1.8	13	240	1000
1.8	14	275	1000
1.8	14	300	1000
1.8	16	375	1000
1.8	16	400	1000
1.8	17	450	1000
1.8	17	485	1000
1.8	19	600	1000
1.8	19	590	1000
1.8	22	800	1000
1.8	23	1010	1000
1.8	25	1400	1000
1.8	28	1850	1000
2.0	32	2550	1000
2.1	36	3400	500
2.2	39	4160	500
2.3	43	5120	500
2.5	46	6340	500
2.7	53	8220	250
2.9	59	10170	250
3.1	67	12890	250
3.4	73	16290	250

re : Round Solid

rm : Round Stranded

sm : Sectoral Stranded

Colour Code:

3 cores: Red, Yellow, Blue

Tolerance range:

Overall diameter $\pm 5\%$

Packing $\pm 5\%$

PVC INSULATED, PVC SHEATHED CABLES

COPPER CONDUCTOR STANDARD:IEC 60502-1

0.6/1 kV

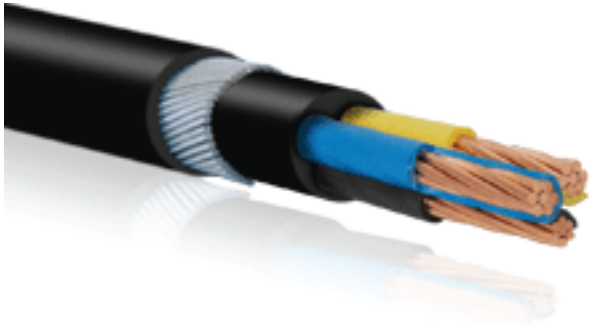

ALUMINIUM WIRE ARMoured

Nominal Alum./Steel Wire diameter	Nominal Sheath Thickness	Approx. Overall diameter	Approx. Weight	Standard Packing
mm	mm	mm	Kg / Km	Meters
-	-	-	-	-
0.8	1.8	14	400	1000
-	-	-	-	-
0.8	1.8	15	470	1000
1.25	1.8	18	685	1000
1.25	1.8	18	740	1000
1.25	1.8	19	800	1000
1.25	1.8	19	850	1000
1.25	1.8	21	1000	1000
1.25	1.8	22	1000	1000
1.25	1.8	24	1270	1000
1.6	1.8	26	1740	1000
1.6	1.8	28	2110	1000
1.6	2.0	32	2680	500
2.0	2.1	38	3710	500
2.0	2.2	40	4730	500
2.0	2.3	43	5590	500
2.5	2.5	47	7160	500
2.5	2.7	53	8560	250
2.5	2.9	59	10700	250
2.5	3.1	65	12900	250
3.15	3.4	74	16820	250
3.15	3.6	80	20600	250

ALUMINIUM TAPE ARMoured

Aluminium / Steel Tape Thickness	Nominal Sheath Thickness	Approx. Overall diameter	Approx. Weight	Standard Packing
mm	mm	mm	Kg / Km	meters
-	-	-	-	-
0.2	1.8	14	300	1000
-	-	-	-	-
0.2	1.8	15	360	1000
0.2	1.8	17	450	1000
0.2	1.8	17	480	1000
0.2	1.8	18	500	1000
0.2	1.8	18	580	1000
0.2	1.8	19	700	1000
0.2	1.8	20	770	1000
0.2	1.8	22	930	1000
0.2	1.8	24	1230	1000
0.2	1.8	26	1550	1000
0.2	1.9	29	2030	1000
0.2	2.0	33	2740	500
0.5	2.2	38	3980	500
0.5	2.3	41	4780	500
0.5	2.4	46	5810	500
0.5	2.6	50	7010	500
0.5	2.8	56	9080	500
0.5	2.9	61	11080	500
0.5	3.2	69	13960	500
0.5	3.4	75	17420	500

PVC INSULATED, PVC SHEATHED CABLES

COPPER CONDUCTOR STANDARD:IEC 60502-1

0.6/1 kV



CABLE CORE(S)

Nominal Area	No. of Wires	Approx. Conductor Diameter	Nominal Insulation Thickness
mm ²	No.	mm	mm
4 x 1.5 re	1	1.38	0.8
4 x 1.5 rm	7	1.56	0.8
4 x 2.5 re	1	1.78	0.8
4 x 2.5 rm	7	2.01	0.8
4 x 4 re	1	2.25	1.0
4 x 4 rm	7	2.55	1.0
4 x 6 re	1	2.76	1.0
4 x 6 rm	7	3.12	1.0
4 x 10 re	1	3.57	1.0
4 x 10 rm	7	4.01	1.0
4 x 16 rm	7	5.03	1.0
4 x 25 sm	7	-	1.2
4 x 35 sm	7	-	1.2
4 x 50 sm	19	-	1.4
4 x 70 sm	19	-	1.4
4 x 95 sm	19	-	1.6
4 x 120 sm	37	-	1.6
4 x 150 sm	37	-	1.8
4 x 185 sm	37	-	2.0
4 x 240 sm	61	-	2.2
4 x 300 sm	61	-	2.4
4 x 400 sm	61	-	2.6
4 x 500 sm	61	-	2.8

UNARMoured

Nominal Sheath Thickness	Approx. Overall Diameter	Approx. Weight	Standard Packing
mm	mm	Kg/Km	meters
1.8	14	250	1000
1.8	14	275	1000
1.8	15	325	1000
1.8	15	335	1000
1.8	17	450	1000
1.8	17	460	1000
1.8	18	550	1000
1.8	18	575	1000
1.8	20	750	1000
1.8	21	730	1000
1.8	24	1010	1000
1.8	25	1390	1000
1.8	28	1800	1000
1.9	32	2410	1000
2.1	36	3300	500
2.2	41	4425	500
2.4	45	5440	500
2.5	49	6700	500
2.7	55	8350	250
2.9	61	10765	250
3.1	67	13360	250
3.4	76	17000	250
3.7	83	21460	250

re: Round Solid
 rm: Round Stranded
 sm : Sectoral Stranded Packing ±5%

Colour Code :
 4 Cores : Red, Yellow, Blue, Black

Tolerance range:
 Overall diameter ±5%

PVC INSULATED, PVC SHEATHED CABLES

COPPER CONDUCTOR STANDARD:IEC 60502-1

0.6/1 kV



STEEL WIRE ARMoured

Steel Wire dia.	Nominal Sheath Thickness	Approx. Overall diameter	Approx. Weight	Standard Packing
mm	mm	mm	Kg/Km	meters
-	-	-	-	-
0.8	1.8	15	450	1000
-	-	-	-	-
0.8	1.8	16	500	-
1.25	1.8	19	790	1000
1.25	1.8	20	825	1000
1.25	1.8	21	950	1000
1.25	1.8	21	975	1000
1.25	1.8	23	1175	1000
1.25	1.8	24	1175	1000
1.6	1.8	27	1675	1000
1.6	1.8	29	2110	1000
1.6	1.9	31	2590	1000
2.0	2.1	37	3615	500
2.0	2.2	40	4580	500
2.5	2.4	46	6340	500
2.5	2.5	50	7525	500
2.5	2.7	55	8950	500
2.5	2.9	60	10850	500
2.5	3.1	66	13580	250
3.15	3.3	73	17250	250
3.15	3.6	83	21375	250
3.15	3.9	90	26330	250

STEEL TAPE ARMoured

Steel Tape Thickness	Nominal Sheath Thickness	Approx. Overall diameter	Approx. Weight	Standard Packing
mm	mm	mm	Kg/Km	meters
-	-	-	-	-
0.2	1.8	14	330	1000
-	-	-	-	-
0.2	1.8	15	390	1000
0.2	1.8	18	525	1000
0.2	1.8	18	550	1000
0.2	1.8	19	640	1000
0.2	1.8	19	675	1000
0.2	1.8	21	850	1000
0.2	1.8	22	850	1000
0.2	1.8	24	1150	1000
0.2	1.8	26	1540	1000
0.2	1.8	29	1950	1000
0.2	2.0	33	2625	500
0.5	2.1	38	3850	500
0.5	2.3	43	5075	500
0.5	2.4	47	6150	500
0.5	2.6	52	7475	500
0.5	2.7	57	9200	500
0.5	3.0	63	11740	250
0.5	3.2	69	14425	250
0.5	3.5	78	18200	250
0.8	3.8	87	23590	250

PVC INSULATED, PVC SHEATHED CABLES

ALUMINIUM CONDUCTOR STANDARD: IEC 60502-1

0.6/1 kV



CABLE CORE(S)

Nominal Area	No. of Wires	Approx. Conductor Diameter	Nominal Insulation Thickness
mm ²	no.	mm	mm
1 x 16 rm	7	5.2	1.0
1 x 25 rm	7	6.0	1.2
1 x 35 rm	7	7.41	1.2
1 x 50 rmc	7	8.30	1.4
1 x 70 rmc	19	9.70	1.4
1 x 95 rmc	19	11.55	1.6
1 x 120 rmc	19	12.95	1.6
1 x 150 rmc	19	14.30	1.8
1 x 185 rmc	37	15.9	2.0
1 x 240 rmc	37	18.4	2.2
1 x 300 rmc	37	20.5	2.4
1 x 400 rmc	61	24.0	2.6
1 x 500 rmc	61	27.0	2.8
1 x 630 rmc	61	30.4	2.8

UNARMoured

Nominal Sheath Thickness	Approx. Overall Diameter	Approx. Weight	Standard Packing
mm	mm	Kg/Km	meters
1.4	10	140	1000
1.4	12	180	1000
1.4	13	230	1000
1.4	14	275	1000
1.4	16	350	1000
1.5	18	475	1000
1.5	20	550	1000
1.6	22	675	1000
1.7	24	825	1000
1.8	27	1060	1000
1.9	30	1300	1000
2.0	33	1650	500
2.1	37	2050	500
2.2	41	2540	500

CABLE CORE(S)

2 x 16 rm	7	5.2	1.0
2 x 25 rm	7	6.30	1.2
2 x 35 rm	7	7.41	1.2

UNARMoured

1.8	20	540	1000
1.8	23	725	1000
1.8	26	875	1000

CABLE CORE(S)

3 x 16 rm	7	5.2	1.0
3 x 25 rm	7	6.30	1.2
3 x 35 rm	7	7.41	1.2
3 x 50 rmc	7	8.30	1.4
3 x 70 rmc	19	9.7	1.4
3 x 95 rmc	19	11.5	1.6
3 x 120 rmc	19	12.95	1.6
3 x 150 rmc	19	14.30	1.8
3 x 185 rmc	37	15.9	2.0
3 x 240 rmc	37	18.4	2.2
3 x 300 rmc	37	20.5	2.4
3 x 400 rmc	61	24.0	2.6
3 x 500 rmc	61	27.0	2.8

UNARMoured

1.8	22	530	1000
1.8	25	720	1000
1.8	28	875	1000
1.8	30	1025	1000
2.0	34	1350	500
2.1	39	1775	500
2.2	43	2090	500
2.3	47	2550	500
2.5	51	3110	500
2.7	59	4050	250
2.9	65	4900	250
3.1	74	6250	250
3.4	82	7775	250

rm: Round Stranded
rmc: Round Stranded Compacted

Colour Code:
1 Core: Black (Red on request)
2 Cores: Red, Black
3 Cores: Red, Yellow, Blue

Tolerance range:
Overall diameter \pm 5%
Packing \pm 5%

PVC INSULATED, PVC SHEATHED CABLES

ALUMINIUM CONDUCTOR STANDARD: IEC 60502-1

0.6/1 kV



ALUMINIUM WIRE ARMoured

Nominal Alum /Steel Wire Diameter	Nominal Sheath Thickness	Approx. Overall diameter	Approx. Weight	Standard Packing
mm	mm	mm	Kg / Km	meters
0.8	1.8	15	300	1000
0.8	1.8	16	350	1000
0.8	1.8	17	410	1000
1.25	1.8	20	525	1000
1.25	1.8	21	625	1000
1.25	1.8	23	775	1000
1.6	1.8	25	925	1000
1.6	1.8	27	1060	1000
1.6	1.8	29	1240	1000
1.6	1.9	32	1530	500
2.0	2.0	36	1900	500
2.0	2.1	40	2375	500
2.0	2.2	44	2850	500
2.0	2.4	48	3425	500

ALUMINIUM TAPE ARMoured

Aluminium / Steel Tape Thickness	Nominal Sheath Thickness	Approx. Overall diameter	Approx. Weight	Standard Packing
mm	mm	mm	Kg/Km	meters
0.5	1.8	15	285	1000
0.5	1.8	17	360	1000
0.5	1.8	18	425	1000
0.5	1.8	20	480	1000
0.5	1.8	21	570	1000
0.5	1.8	24	710	1000
0.5	1.8	25	800	1000
0.5	1.8	27	950	1000
0.5	1.8	29	1100	1000
0.5	1.9	32	1380	500
0.5	1.9	35	1620	500
0.5	2.1	39	2070	500
0.5	2.2	43	2530	500
0.5	2.3	45	3050	500

STEEL WIRE ARMoured

1.25	1.8	24	980	1000
1.6	1.8	27	1400	1000
1.6	1.8	29	1610	1000

STEEL TAPE ARMoured

0.2	1.8	21	650	1000
0.2	1.8	24	860	1000
0.2	1.8	26	1030	1000

STEEL WIRE ARMoured

1.25	1.8	25	1000	1000
1.6	1.8	28	1420	1000
1.6	1.8	31	1650	1000
1.6	2.0	34	1930	500
2.0	2.1	39	2590	500
2.0	2.2	44	3200	500
2.0	2.3	47	3625	500
2.5	2.5	52	4725	500
2.5	2.7	57	5500	250
2.5	2.9	64	6775	250
2.5	3.1	70	7875	250
3.15	3.4	81	10600	250
3.15	3.6	88	12550	250

STEEL TAPE ARMoured

0.2	1.8	23	660	1000
0.2	1.8	26	860	1000
0.2	1.8	28	1025	1000
0.2	1.9	32	1225	1000
0.2	2.0	35	1550	500
0.5	2.2	41	2400	500
0.5	2.3	45	2770	500
0.5	2.4	49	3300	500
0.5	2.6	54	3940	500
0.5	2.8	61	4980	500
0.5	3.0	66	5900	500
0.5	3.2	76	7450	250
0.5	3.4	83	9050	250

PVC INSULATED, PVC SHEATHED CABLES

ALUMINIUM CONDUCTOR STANDARD: IEC 60502-1

0.6/1 kV



CABLE CORE(S)

Nominal Area	No. of Wires	Approx. Conductor Diameter	Nominal Insulation Thickness
mm ²	No.	mm	mm
4 x 16 rm	7	5.2	1.0
4 x 25 rm	7	6.30	1.2
4 x 35 sm	7	-	1.2
4 x 50 sm	7	-	1.4
4 x 70 sm	19	-	1.4
4 x 95 sm	19	-	1.6
4 x 120 sm	19	-	1.6
4 x 150 sm	37	-	1.8
4 x 185 sm	37	-	2.0
4 x 240 sm	61	-	2.2
4 x 300 sm	61	-	2.4
4 x 400 sm	61	-	2.6
4 x 500 sm	61	-	2.8

rm: Round Stranded
sm: Sectoral Stranded

UNARMoured

Nominal Sheath Thickness	Approx. Overall Diameter	Approx. Weight	Standard Packing
mm	mm	Kg/Km	meters
1.8	24	640	1000
1.8	27	875	1000
1.8	28	950	1000
1.9	32	1260	500
2.1	36	1630	500
2.2	41	2110	500
2.3	45	2525	500
2.5	49	3075	500
2.7	55	3800	500
2.9	61	4825	250
3.1	67	5890	250
3.4	76	7475	250
3.7	83	9250	250

Colour Code :
3½ Cores : Red, Yellow, Blue, Black
4 Cores: Red, Yellow, Blue, Black

Tolerance Range:
Overall diameter ±5%
Packing ±5%

PVC INSULATED, PVC SHEATHED CABLES

ALUMINIUM CONDUCTOR STANDARD:IE 60502-1

0.6/1 kV

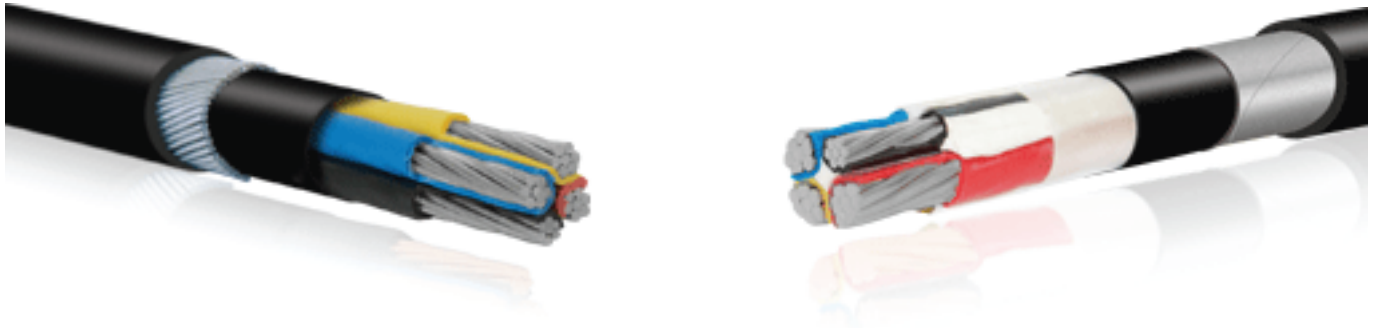

STEEL WIRE ARMoured

Steel Wire Diameter	Nominal Sheath Thickness	Approx. Overall diameter	Approx. Weight	Standard Packing
mm	mm	mm	Kg /Km	meters
1.6	1.8	27	1310	1000
1.6	1.8	31	1640	1000
1.6	1.9	31	1750	500
2.0	2.1	37	2470	500
2.0	2.2	40	2930	500
2.5	2.4	46	4025	500
2.5	2.5	50	4600	500
2.5	2.7	55	5325	500
2.5	2.9	60	6320	250
2.5	3.1	66	7650	250
3.15	3.3	73	9790	250
3.15	3.6	83	11850	250
3.15	3.9	90	14100	250

STEEL TAPE ARMoured

Steel Tape Thickness	Nominal Sheath Thickness	Approx. Overall diameter	Approx. Weight	Standard Packing
mm	mm	mm	Kg/Km	meters
0.2	1.8	25	775	1000
0.2	1.8	28	1030	1000
0.2	1.8	29	1110	1000
0.2	2.0	33	1475	500
0.5	2.1	38	2175	500
0.5	2.3	43	2760	500
0.5	2.4	47	3230	500
0.5	2.6	51	3850	500
0.5	2.7	57	4650	500
0.5	3.0	63	5800	250
0.5	3.2	69	6950	250
0.5	3.5	78	8675	250
0.8	3.8	87	11380	250

XLPE INSULATED, PVC SHEATHED CABLES

COPPER CONDUCTORS STANDARD: IEC 60502-1

0.6/1 kV



CABLE CORE(S)

Nominal Area	No. of Wires	Approx. Conductor Diameter	Nominal Insulation Thickness
mm ²	No.	mm	mm
1 x 1.5re	1	1.38	0.7
1 x 1.5rm	7	1.56	0.7
1 x 2.5re	1	1.78	0.7
1 x 2.5rm	7	2.01	0.7
1 x 4 re	1	2.25	0.7
1 x 4 rm	7	2.55	0.7
1 x 6 re	1	2.76	0.7
1 x 6 rm	7	3.12	0.7
1 x 10rm	7	4.01	0.7
1 x 16rm	7	5.03	0.7
1 x 25rm	7	6.3	0.9
1 x 35rm	7	7.44	0.9
1 x 50rmc	19	8.1	1.0
1 x 70rmc	19	9.7	1.1
1 x 95rmc	19	11.4	1.1
1 x 120rmc	37	12.9	1.2
1 x 150rmc	37	14.3	1.4
1 x 185rmc	37	16.0	1.6
1 x 240rmc	61	18.4	1.7
1 x 300rm	61	20.4	1.8
1 x 400rmc	61	23.2	2.0
1 x 500rmc	61	26.7	2.2
1 x 630rmc	61	30.4	2.4
1 x 800rmc	61	33.7	2.6
1 x 1000rm	91	41.0	2.8

UNARMoured

Nominal Sheath Thickness	Approx. Overall Diameter	Approx. Weight	Standard Packing
mm	mm	Kg/Km	meters
1.4	6	45	1000
1.4	6	50	1000
1.4	6	60	1000
1.4	7	60	1000
1.4	7	75	1000
1.4	7	80	1000
1.4	7	95	1000
1.4	8	100	1000
1.4	9	145	1000
1.4	10	200	1000
1.4	11	300	1000
1.4	12	400	1000
1.4	13	515	1000
1.4	15	720	1000
1.5	17	975	1000
1.5	19	1210	1000
1.6	21	1490	1000
1.6	23	1850	1000
1.7	25	2400	1000
1.8	28	3000	1000
1.9	31	3800	500
2.0	35	4850	500
2.2	40	6250	500
2.3	44	7950	500
2.4	51	10180	250

CABLE CORE(S)

2 x 1.5re	1	1.38	0.7
2 x 1.5rm	7	1.56	0.7
2 x 2.5re	1	1.78	0.7
2 x 2.5rm	7	2.01	0.7
2 x 4 re	1	2.25	0.7
2 x 4 rm	7	2.55	0.7
2 x 6 re	1	2.76	0.7
2 x 6 rm	7	3.12	0.7
2 x 10rm	7	4.01	0.7
2 x 16rm	7	5.03	0.7
2 x 25sm	7	-	0.9
2 x 35sm	7	-	0.9

UNARMoured

1.8	12	175	1000
1.8	12	200	1000
1.8	13	225	1000
1.8	13	225	1000
1.8	14	275	1000
1.8	14	270	1000
1.8	15	325	1000
1.8	15	340	1000
1.8	17	455	1000
1.8	19	620	1000
1.8	19	715	1000
1.8	21	915	1000

re: Round Solid
 rm: Round Stranded
 rmc: Round Stranded Compacted

Colour Code:
 1 Core: Black (red on request)
 2 Cores: Red, Black

Tolerance range:
 Overall diameter ± 5%
 Packing ± 5%

XLPE INSULATED, PVC SHEATHED CABLES

COPPER CONDUCTOR STANDARD:IEC 60502-1

0.6/1 kV

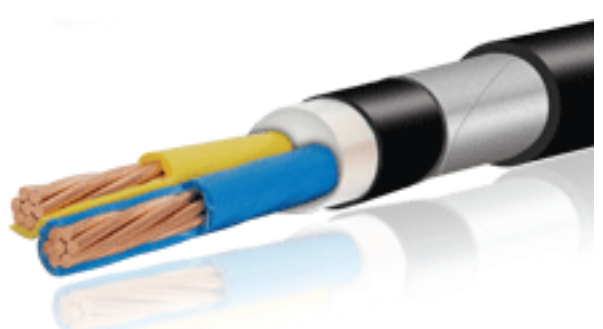
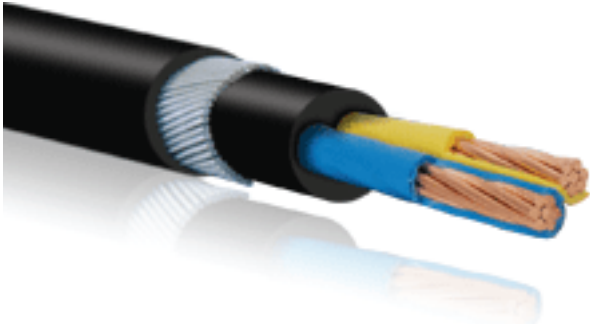

ALUMINIUM WIRE ARMoured

Nominal Alum ./ Steel Wire Diameter	Nominal Sheath Thickness	Approx . Overall diameter	Approx . Weight	Standard Packing
mm	mm	mm	Kg/Km	meters
-	-	-	-	-
0.8	1.8	10	150	-
-	-	-	-	-
0.8	1.8	11	150	-
-	-	-	-	-
0.8	1.8	11	175	-
-	-	-	-	-
0.8	1.8	12	225	-
0.8	1.8	13	275	-
0.8	1.8	16	435	-
0.8	1.8	17	570	1000
0.8	1.8	18	680	1000
1.25	1.8	19	820	1000
1.25	1.8	21	1055	1000
1.25	1.8	22	1330	1000
1.6	1.8	24	1600	1000
1.6	1.8	26	1900	1000
1.6	1.8	28	2300	1000
1.6	1.9	31	2900	500
1.6	2.0	33	3540	500
2.0	2.1	38	3540	500
2.0	2.2	42	5635	500
2.0	2.3	46	7100	500
2.5	2.5	52	9120	250
2.5	2.7	60	11290	250

ALUMINIUM TAPE ARMoured

Aluminium / Steel Tape Thickness	Nominal Sheath Thickness	Approx . Overall diameter	Approx . Weight	Standard Packing
mm	mm	mm	Kg/Km	meters
-	-	-	-	-
-	-	-	-	-
-	-	-	-	-
-	-	-	-	-
-	-	-	-	-
-	-	-	-	-
-	-	-	-	-
-	-	-	-	-
-	-	-	-	-
-	-	-	-	-
0.5	1.8	16	460	1000
0.5	1.8	17	570	1000
0.5	1.8	18	700	1000
0.5	1.8	20	930	1000
0.5	1.8	21	1220	1000
0.5	1.8	23	1460	1000
0.5	1.8	25	1750	1000
0.5	1.8	27	2130	1000
0.5	1.8	29	2700	500
0.5	1.9	32	3320	500
0.5	2.0	36	4210	500
0.5	2.1	40	5310	500
0.5	2.3	44	6760	500
-	-	-	-	-
-	-	-	-	-

STEEL WIRE ARMoured

-	-	-	-	-
0.8	1.8	14	325	1000
-	-	-	-	-
0.8	1.8	15	380	1000
0.8	1.8	15	450	1000
0.8	1.8	16	450	1000
0.8	1.8	16	525	1000
0.8	1.8	17	530	1000
1.25	1.8	19	810	1000
1.25	1.8	21	1020	1000
1.6	1.8	25	1525	1000
1.6	1.8	28	1850	1000

STEEL TAPE ARMoured

-	-	-	-	-
0.2	1.8	13	250	1000
-	-	-	-	-
0.2	1.8	13	300	1000
0.2	1.8	15	350	1000
0.2	1.8	15	350	1000
0.2	1.8	15	350	1000
0.2	1.8	16	400	1000
0.2	1.8	16	440	1000
0.2	1.8	18	570	1000
0.2	1.8	20	750	1000
0.2	1.8	20	830	1000
0.2	1.8	22	1040	1000

XLPE INSULATED, PVC SHEATHED CABLES

COPPER CONDUCTOR STANDARD:IEC 60502-1

0.6/1 kV



CABLE CORE(S)

Nominal Area	No. of Wires	Approx. Conductor diameter	Nominal Insulation Thickness
mm ²	No.	mm	mm
3x1.5re	1	1.38	0.7
3x1.5rm	7	1.56	0.7
3x2.5re	1	1.78	0.7
3x2.5rm	7	2.01	0.7
3x4re	1	2.25	0.7
3x4rm	7	2.55	0.7
3x6re	1	2.76	0.7
3x6rm	7	3.12	0.7
3x10rm	7	4.01	0.7
3x16rm	7	5.03	0.7
3x25sm	7	-	0.9
3x35sm	7	-	0.9
3x50sm	19	-	1.0
3x70sm	19	-	1.1
3x95sm	19	-	1.1
3x120sm	37	-	1.2
3x150sm	37	-	1.4
3x185sm	37	-	1.6
3x240sm	61	-	1.7
3x300sm	61	-	1.8
3x400sm	61	-	2.0
3x500sm	61	-	2.2

UNARMoured

Nominal Sheath Thickness	Approx. Overall diameter	Approx. Weight	Stranded Packing
mm	mm	Kg/Km	meters
1.8	13	200	1000
1.8	12	210	1000
1.8	13	250	1000
1.8	13	260	1000
1.8	14	325	1000
1.8	15	335	1000
1.8	15	400	1000
1.8	16	410	1000
1.8	18	525	1000
1.8	20	725	1000
1.8	21	1000	1000
1.8	23	1300	1000
1.8	26	1690	1000
1.9	30	2370	500
2.0	34	3140	500
2.1	37	3900	500
2.3	42	4830	500
2.4	46	5970	500
2.6	51	7750	250
2.8	56	9580	250
3.1	64	12150	250
3.3	70	15470	250

re: Round Solid
rm: Round Stranded
sm: Sectoral Stranded

Colour Code :
3 Cores : Red, Yellow, Blue

Tolerance Range:
Overall diameter ±5%
Packing ±5%

XLPE INSULATED, PVC SHEATHED CABLES

COPPER CONDUCTORS STANDARD: IEC 60502-1

0.6/1 kV



STEEL WIRE ARMoured

STEEL TAPE ARMoured

Steel Wire Diameter	Nominal Sheath Thickness	Approx . Overall diameter	Approx . Weight	Standard Packing
mm	mm	mm	Kg/Km	meters
-	-	-	-	-
0.8	1.8	14	370	1000
-	-	-	-	-
0.8	1.8	15	440	1000
-	-	-	-	-
0.8	1.8	16	530	1000
0.8	1.8	17	575	1000
0.8	1.8	17	630	1000
1.25	1.8	20	900	1000
1.25	1.8	23	1160	1000
1.6	1.8	25	1600	1000
1.6	1.8	27	1970	1000
1.6	1.9	30	2460	1000
2.0	2.0	35	3480	500
2.0	2.2	41	4600	500
2.0	2.3	41	5270	500
2.5	2.5	47	6790	500
2.5	2.6	51	8100	250
2.5	2.8	57	10130	250
2.5	3.0	62	12190	250
2.5	3.2	69	15070	250
3.15	3.5	77	19580	250

Steel Tape Thickness	Nominal Sheath Thickness	Approx . Overall diameter	Approx . Weight	Standard Packing
mm	mm	mm	Kg/Km	meters
-	-	-	-	-
0.2	1.8	13	275	1000
-	-	-	-	-
0.2	1.8	14	310	1000
-	-	-	-	-
0.2	1.8	15	390	1000
0.2	1.8	16	475	1000
0.2	1.8	17	470	1000
0.2	1.8	19	630	1000
0.2	1.8	21	850	1000
0.2	1.8	22	1130	1000
0.2	1.8	24	1430	1000
0.2	1.8	27	1845	1000
0.2	1.9	31	2550	500
0.2	2.1	35	3360	500
0.5	2.2	40	4490	500
0.5	2.4	44	5490	500
0.5	2.5	48	6700	500
0.5	2.7	53	8560	250
0.5	2.9	58	10480	250
0.5	3.1	65	13130	250
0.5	3.3	73	16560	250

XLPE INSULATED, PVC SHEATHED CABLES

COPPER CONDUCTOR STANDARD:IEC 60502-1

0.6/1 kV



CABLE CORE(S)

Nominal Area	No. of Wires	Approx. Conductor diameter	Nominal Insulation Thickness
mm ²	No.	mm	mm
4x 1.5re	1	1.38	0.7
4x 1.5rm	7	1.56	0.7
4x 2.5re	1	1.78	0.7
4x 2.5rm	7	2.01	0.7
4x 4 re	1	2.25	0.7
4x 4 rm	7	2.55	0.7
4x 6re	1	2.76	0.7
4x 6rm	7	3.12	0.7
4x 10re	1	3.57	0.7
4x 10rm	7	4.01	0.7
4x 16rm	7	5.03	0.7
4x 25sm	7	-	0.9
4x 35sm	7	-	0.9
4x 50sm	19	-	1.0
4x 70sm	19	-	1.1
4x 95sm	19	-	1.1
4x 120sm	37	-	1.2
4x 150sm	37	-	1.4
4x 185sm	37	-	1.6
4x 240sm	61	-	1.7
4x 300sm	61	-	1.8
4x 400sm	61	-	2.0
4x 500sm	61	-	2.2

UNARMoured

Nominal Sheath Thickness	Approx. Overall diameter	Approx. Weight	Standard Packing
mm	mm	Kg/Km	meters
1.8	14	250	1000
1.8	13	250	1000
1.8	15	300	1000
1.8	14	300	1000
1.8	16	400	1000
1.8	16	390	1000
1.8	18	500	1000
1.8	17	490	1000
1.8	20	650	1000
1.8	19	650	1000
1.8	22	900	1000
1.8	26	1350	1000
1.8	26	1650	1000
1.9	30	2180	1000
2.0	34	3050	500
2.1	38	4100	500
2.3	42	5125	500
2.4	47	6290	500
2.6	52	7815	500
2.8	58	10150	250
3.0	64	12590	250
3.3	73	16090	250
3.5	80	20380	250

re: Round Solid
rm: Round Stranded
sm : Sectoral Stranded

Colour Code :
4 Cores : Red, Yellow, Blue, Black

Tolerance range:
Overall diameter $\pm 5\%$
Packing $\pm 5\%$

XLPE INSULATED, PVC SHEATHED CABLES

COPPER CONDUCTORS STANDARD: IEC 60502-1

0.6/1 kV



STEEL WIRE ARMoured

Steel Wire dia.	Nominal Sheath thickness	Approx. Overall diameter	Approx. Weight	Standard Packing
mm	mm	mm	Kg/Km	meters
0.8	1.8	15	410	1000
0.8	1.8	15	400	1000
0.8	1.8	16	490	1000
0.8	1.8	16	475	1000
0.8	1.8	17	550	1000
0.8	1.8	17	600	1000
1.25	1.8	19	775	1000
1.25	1.8	20	825	1000
1.25	1.8	22	1010	1000
1.25	1.8	22	1060	1000
1.6	1.8	25	1525	1000
1.6	1.8	29	2075	1000
1.6	1.9	29	2400	1000
1.6	2.0	33	3030	1000
2.0	2.2	38	4320	500
2.0	2.3	42	5500	500
2.5	2.5	48	7080	500
2.5	2.6	52	8460	500
2.5	2.8	57	10200	250
2.5	3.0	63	12850	250
2.5	3.2	69	15540	250
3.15	3.5	79	20325	250
3.15	3.8	87	25075	250

STEELTAPE ARMoured

Steel Tape Thickness	Nominal Sheath Thickness	Approx. Overall diameter	Approx. Weight	Standard Packing
mm	mm	mm	Kg/Km	meters
-	-	-	-	-
0.2	1.8	14	300	1000
-	-	-	-	-
0.2	1.8	15	360	1000
0.2	1.8	16	455	1000
0.2	1.8	16	450	1000
0.2	1.8	17	560	1000
0.2	1.8	18	555	1000
0.2	1.8	19	750	1000
0.2	1.8	20	760	1000
0.2	1.8	23	1030	1000
0.2	1.8	24	1400	1000
0.2	1.8	27	1800	1000
0.2	1.9	31	2360	500
0.2	2.0	35	3280	500
0.5	2.2	40	4700	500
0.5	2.4	45	5800	500
0.5	2.5	49	7040	500
0.5	2.7	54	8650	500
0.5	2.9	60	11080	500
0.5	3.1	66	13620	500
0.5	3.4	75	17250	500
0.8	3.7	84	22450	250

XLPE INSULATED, PVC SHEATHED CABLES

ALUMINIUM CONDUCTOR STANDARD: IEC 60502-1

0.6/1 kV



CABLE CORE(S)

Nominal Area	No. of wires	Approx. conductor diameter	Nominal Insulation Thickness
mm ²	No.	mm	mm
1 x 16 rm	7	5.20	0.7
1 x 25 rm	7	6.30	0.9
1 x 35 rm	7	7.41	0.9
1 x 50 rmc	7	8.30	1.0
1 x 70 rmc	19	9.70	1.1
1 x 95 rmc	19	11.55	1.1
1 x 120 rmc	37	12.95	1.2
1 x 150 rmc	37	14.3	1.4
1 x 185 rmc	37	15.9	1.6
1 x 240 rmc	61	18.4	1.7
1 x 300 rmc	61	20.5	1.8
1 x 400 rmc	61	24.0	2.0
1 x 500 rmc	61	27.0	2.2
1 x 630 rmc	61	30.4	2.4

UNARMoured

Nominal Sheath Thickness	Approx. Overall Diameter	Approx. Weight	Standard Packing
mm	mm	Kg/Km	meters
1.4	10	110	1000
1.4	11	150	1000
1.4	12	200	1000
1.4	13	230	1000
1.4	15	300	1000
1.5	18	400	1000
1.5	19	490	1000
1.6	20	590	1000
1.6	23	720	1000
1.7	25	930	1000
1.8	28	1130	1000
1.9	32	1500	500
2.0	35	1820	500
2.2	40	2320	500

CABLE CORE(S)

2 x 16 rm	7	5.20	0.7
2 x 25 rm	7	6.30	0.9
2 x 35 rm	7	7.41	0.9

UNARMoured

1.8	19	460	1000
1.8	22	630	1000
1.8	24	770	1000

CABLE CORE(S)

3 x 16 rm	7	5.10	0.7
3 x 25 rm	7	6.30	0.9
3 x 35 rm	7	7.41	0.9
3 x 50 rmc	19	8.30	1.0
3 x 70 rmc	19	9.7	1.1
3 x 95 rmc	19	11.55	1.1
3 x 120 rmc	37	12.95	1.2
3 x 150 rmc	37	14.3	1.4
3 x 185 rmc	37	15.9	1.6
3 x 240 rmc	61	18.4	1.7
3 x 300 rmc	61	20.5	1.8
3 x 400 rmc	61	24.0	2.0
3 x 500 rmc	61	27.0	2.2

UNARMoured

1.8	21	450	1000
1.8	24	600	1000
1.8	26	750	1000
1.8	29	880	1000
1.9	34	1180	500
2.0	37	1530	500
2.1	40	1840	500
2.3	45	2290	500
2.4	49	2780	250
2.6	56	3600	250
2.8	61	4350	250
3.1	70	5570	250
3.3	79	7010	250

re: Round Solid
 rm: Round Stranded
 rmc: Round Stranded Compacted

Colour Code:
 1 Core: Black (Red on request)
 2 Cores: Red, Black
 3 Cores: Red, Yellow, Blue

Tolerance range:
 Overall diameter ± 5%
 Packing ± 5%

XLPE INSULATED, PVC SHEATHED CABLES

ALUMINIUM CONDUCTOR STANDARD: IEC 60502-1

0.6/1 kV

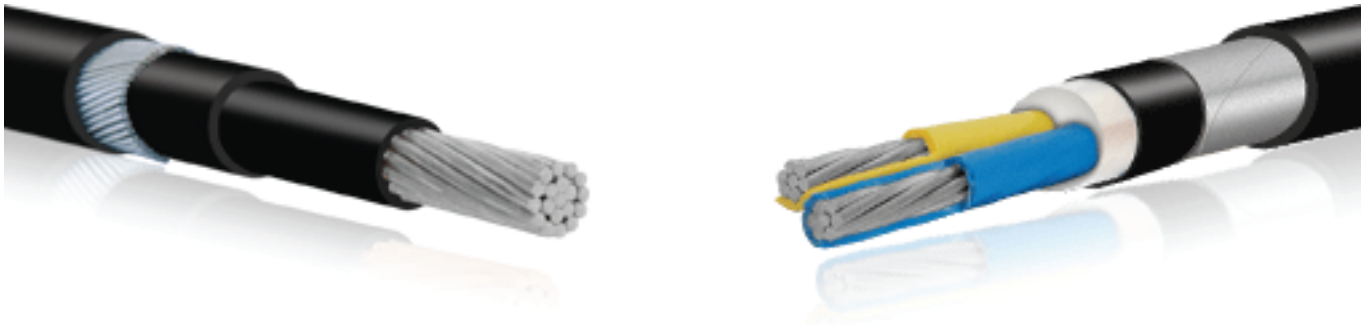

ALUMINIUM WIRE ARMoured

Nominal Alum / Steel Wire Diameter	Nominal Sheath Thickness	Approx. Overall diameter	Approx. Weight	Standard Packing
mm	mm	mm	Kg/Km	meters
0.8	1.8	14	255	1000
0.8	1.8	16	320	1000
0.8	1.8	17	370	1000
1.25	1.8	19	470	1000
1.25	1.8	20	570	1000
1.25	1.8	22	690	1000
1.6	1.8	24	840	1000
1.6	1.8	26	980	1000
1.6	1.8	28	1130	1000
1.6	1.9	30	1400	500
1.6	1.9	33	1620	500
2.0	2.1	39	2170	500
2.0	2.2	42	2610	250
2.0	2.3	46	3170	250

ALUMINIUM WIRE ARMoured

Aluminium / Steel tape Thickness	Nominal Sheath Thickness	Approx. Overall diameter	Approx. Weight	Standard Packing
mm	mm	mm	Kg/Km	meters
-	-	-	-	-
-	-	-	-	-
-	-	-	-	-
0.5	1.8	17	420	500
0.5	1.8	19	520	500
0.5	1.8	20	630	500
0.5	1.8	22	730	500
0.5	1.8	24	850	500
0.5	1.8	26	1000	500
0.5	1.8	28	1240	500
0.5	1.9	31	1470	500
0.5	2.0	35	1870	500
0.5	2.1	40	2650	250
0.5	2.3	44	3240	250

STEEL WIRE ARMoured

1.25	1.8	22	880	1000
1.6	1.8	25	1270	1000
1.6	1.8	28	1470	1000

STEEL WIRE ARMoured

0.2	1.8	20	570	1000
0.2	1.8	23	750	1000
0.2	1.8	25	900	500

STEEL WIRE ARMoured

1.25	1.8	23	880	1000
1.6	1.8	27	1275	1000
1.6	1.8	29	1480	1000
1.6	1.9	32	1720	500
2.0	2.0	37	2370	500
2.0	2.2	41	2900	500
2.0	2.3	45	3350	500
2.5	2.5	50	4370	500
2.5	2.6	55	5080	250
2.5	2.8	62	6200	250
2.5	3.0	67	7200	250
2.5	3.2	76	8770	250
3.15	3.5	85	11580	250

STEEL WIRE ARMoured

0.2	1.8	21	570	1000
0.2	1.8	25	750	1000
0.2	1.8	27	900	500
0.2	1.8	30	1050	500
0.2	1.9	33	1380	500
0.5	2.1	38	1770	500
0.5	2.2	43	2490	500
0.5	2.4	47	3000	250
0.5	2.5	52	3570	250
0.5	2.7	58	4500	250
0.5	2.9	64	5330	250
0.5	3.1	72	6660	250
0.5	3.3	81	8240	250

XLPE INSULATED, PVC SHEATHED CABLES

ALUMINIUM CONDUCTOR STANDARD: IEC 60502-1

0.6/1 kV

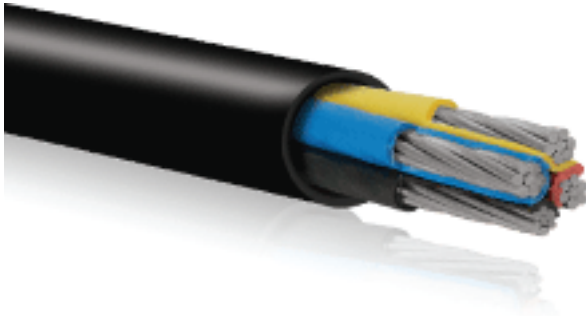

CABLE CORE(S)

Nominal Area	No. of Wires	Approx. Conductor diameter	Nominal Insulation Thickness
mm ²	No.	mm	mm
4 x 16rm	7	5.2	0.7
4 x 25rm	7	6.30	0.9
4 x 35sm	7	-	0.9
4 x 50sm	19	-	1.0
4 x 70sm	19	-	1.1
4 x 95sm	19	-	1.1
4 x 120sm	37	-	1.2
4 x 150sm	37	-	1.4
4 x 185sm	37	-	1.6
4 x 240sm	37	-	1.7
4 x 300sm	61	-	1.8
4 x 400sm	61	-	2.0
4 x 500sm	61	-	2.2

rm: Round Stranded
sm: Sectoral Stranded

Colour Code :
4 Cores: Red, Yellow, Blue, Black

UNARMoured

Nominal Sheath Thickness	Approx. Overall diameter	Approx. Weight	Standard Packing
mm	mm	Kg/Km	meters
1.8	22	540	1000
1.8	26	740	1000
1.8	26	800	1000
1.9	30	1025	1000
2.0	34	1400	500
2.1	38	1780	500
2.3	42	2200	500
2.4	47	2670	500
2.6	52	3275	250
2.8	58	4225	250
3.0	64	5130	250
3.3	72	6550	250
3.5	80	8150	250

Tolerance Range:
Overall diameter $\pm 5\%$
Packing $\pm 5\%$

XLPE INSULATED, PVC SHEATHED CABLES

ALUMINIUM CONDUCTOR STANDARD: IEC 60502-1

0.6/1 kV

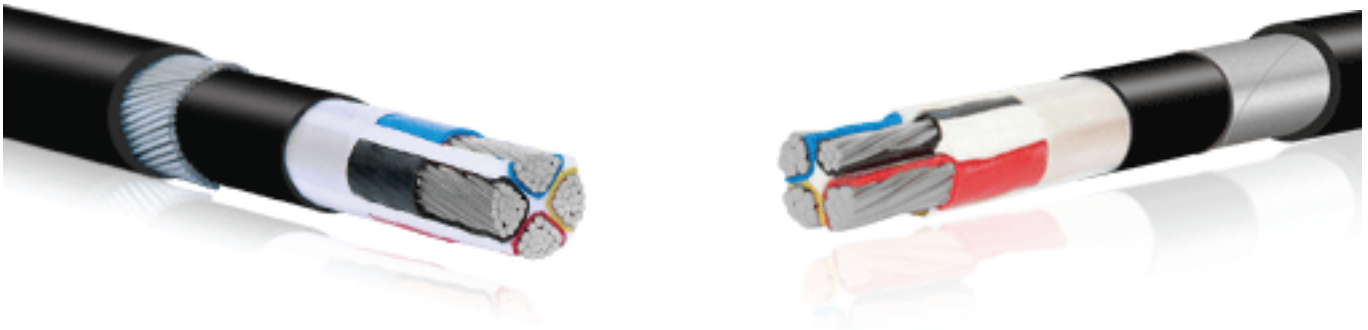

STEEL WIRE ARMoured

Steel Wire Diameter	Nominal Sheath Thickness	Approx. Overall diameter	Approx. Weight	Standard Packing
mm	mm	mm	Kg/Km	meters
1.6	1.8	26	1160	1000
1.6	1.8	29	1475	1000
1.6	1.9	30	1550	500
1.6	2.0	33	1890	500
2.0	2.2	39	2670	500
2.0	2.3	43	3190	500
2.5	2.5	48	4170	500
2.5	2.6	52	4840	500
2.5	2.8	57	5670	250
2.5	3.0	63	6900	250
2.5	3.2	69	8070	250
3.15	3.5	79	10800	250
3.15	3.8	87	12840	250

STEEL TAPE ARMoured

Steel Tape Thickness	Nominal Sheath Thickness	Approx. Overall diameter	Approx. Weight	Standard Packing
mm	mm	mm	Kg/Km	meters
0.2	1.8	23	670	1000
0.2	1.8	27	890	1000
0.2	1.8	27	960	500
0.2	1.9	31	1200	500
0.2	2.0	35	1600	500
0.5	2.2	40	2390	500
0.5	2.4	45	2890	250
0.5	2.5	49	3420	250
0.5	2.7	54	4100	250
0.5	2.9	60	5150	250
0.5	3.1	66	6150	250
0.5	3.4	75	7725	250
0.8	3.7	84	10240	250

XLPE INSULATED, LSZH SHEATHED CABLES

COPPER CONDUCTOR STANDARD:IEC 60502-1

0.6/1 kV



CABLE CORE(S)

Nominal Area	No. of wires	Approx. conductor diameter	Nominal Insulation Thickness
mm ²	No.	mm	mm
1 x 1.5 re	1	1.38	0.7
1 x 1.5 rm	7	1.56	0.7
1 x 2.5 re	1	1.8	0.7
1 x 2.5 rm	7	1.98	0.7
1 x 4 re	1	2.25	0.7
1 x 4 rm	7	2.52	0.7
1 x 6 re	1	2.76	0.7
1 x 6 rm	7	3.12	0.7
1 x 10 rm	7	4.01	0.7
1 x 16 rm	7	5.03	0.7
1 x 25 rm	7	6.3	0.9
1 x 35 rm	7	7.44	0.9
1 x 50 rmc	19	8.1	1.0
1 x 70 rmc	19	9.7	1.1
1 x 95 rmc	19	11.4	1.1
1 x 120 rmc	37	12.9	1.2
1 x 150 rmc	37	14.3	1.4
1 x 185 rmc	37	16.0	1.6
1 x 240 rmc	61	18.4	1.7
1 x 300 rmc	61	20.4	1.8
1 x 400 rmc	61	23.2	2.0
1 x 500 rmc	61	26.7	2.2
1 x 630 rmc	61	30.4	2.4

CABLE CORE(S)

2 x 1.5 re	1	1.38	0.7
2 x 1.5 rm	7	1.56	0.7
2 x 2.5 re	1	1.78	0.7
2 x 2.5 rm	7	1.98	0.7
2 x 4 re	1	2.25	0.7
2 x 4 rm	7	2.52	0.7
2 x 6 re	1	2.76	0.7
2 x 6 rm	7	3.12	0.7
2 x 10 re	1	4.01	0.7
2 x 16 rm	7	5.03	0.7
2 x 25 rm	7	6.3	0.9
2 x 35 rm	7	7.44	0.9

UNARMoured

Nominal Sheath Thickness	Approx. Overall Diameter	Approx. Weight	Standard Packing
mm	no.	Kg/Km	meters
1.4	6	45	1000
1.4	6	50	1000
1.4	6	60	1000
1.4	7	60	1000
1.4	7	75	1000
1.4	7	80	1000
1.4	7	95	1000
1.4	8	100	1000
1.4	9	145	1000
1.4	10	200	1000
1.4	11	300	1000
1.4	12	400	1000
1.4	13	520	1000
1.4	15	720	1000
1.5	17	990	1000
1.5	18	1210	1000
1.6	20	1490	1000
1.6	22	1860	1000
1.7	25	2420	1000
1.8	27	3020	1000
1.9	31	3850	1000
2.0	35	4900	500
2.2	40	6250	500

UNARMoured

1.8	12	175	1000
1.8	12	190	1000
1.8	13	225	1000
1.8	13	225	1000
1.8	14	275	1000
1.8	14	275	1000
1.8	15	325	1000
1.8	15	350	1000
1.8	17	470	1000
1.8	19	640	1000
1.8	22	925	1000
1.8	24	1185	1000

re: Round Solid
rm: Round Stranded

Colour Code :
1 Core : Black (red on request)
2 Cores : Red , Black

Tolerance range :
Overall diameter ± 5%
Packing ± 5%

XLPE INSULATED, LSZH SHEATHED CABLES

COPPER CONDUCTOR STANDARD: IEC 60502-1

0.6/1 kV

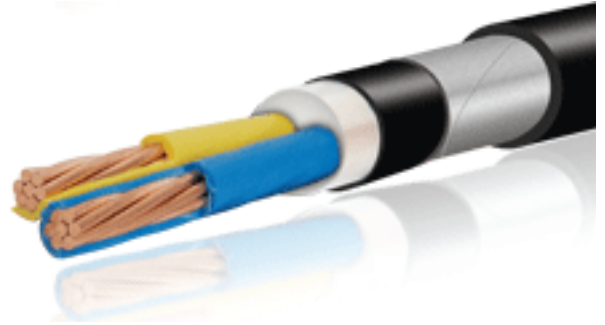

ALUMINIUM WIRE ARMoured

Nominal Alum./ Steel Wire diameter	Nominal Sheath Thickness	Approx Overall diameter	Approx Weight	Standard Packing
mm	mm	mm	Kg/Km	meters
-	-	-	-	-
0.8	1.8	11	150	1000
-	-	-	-	-
0.8	1.8	11	150	1000
-	-	-	-	-
0.8	1.8	12	200	1000
-	-	-	-	-
0.8	1.8	12	210	1000
0.8	1.8	13	275	1000
0.8	1.8	14	340	1000
0.8	1.8	16	460	1000
0.8	1.8	17	575	1000
1.25	1.8	18	740	1000
1.25	1.8	20	980	1000
1.25	1.8	21	1260	1000
1.6	1.8	24	1560	1000
1.6	1.8	26	1880	1000
1.6	1.8	27	2270	1000
1.6	1.9	30	2870	500
1.6	1.9	33	3500	500
2.0	2.1	38	4550	500
2.0	2.2	42	5680	500
2.0	2.3	47	7075	500

ALUMINIUM TAPE ARMoured

Aluminium/ Steel Tape Thickness	Nominal Sheath Thickness	Approx Overall diameter	Approx Weight	Standard Packing
mm	mm	mm	Kg/Km	meters
-	-	-	-	-
-	-	-	-	-
-	-	-	-	-
-	-	-	-	-
-	-	-	-	-
-	-	-	-	-
-	-	-	-	-
-	-	-	-	-
-	-	-	-	-
0.5	1.8	16	475	1000
0.5	1.8	17	580	1000
0.5	1.8	18	700	1000
0.5	1.8	19	930	1000
0.5	1.8	21	1210	1000
0.5	1.8	22	1460	1000
0.5	1.8	24	1760	1000
0.5	1.8	26	2130	1000
0.5	1.8	29	2710	500
0.5	1.9	31	3340	500
0.5	2.0	36	4250	500
0.5	2.1	40	5350	500
0.5	2.3	43	6950	500

STEEL WIRE ARMoured

0.8	1.8	14	-	-
-	-	-	-	-
0.8	1.8	15	-	-
-	-	-	-	-
0.8	1.8	15	450	1000
0.8	1.8	16	460	1000
0.8	1.8	16	525	1000
0.8	1.8	17	550	1000
1.25	1.8	19	835	1000
1.25	1.8	21	1050	1000
1.6	1.8	25	1560	1000
1.6	1.8	28	1890	1000

STEEL TAPE ARMoured

-	-	-	-	-
-	-	-	-	-
-	-	-	-	-
-	-	-	-	-
0.2	1.8	15	350	1000
0.2	1.8	15	360	1000
0.2	1.8	16	400	1000
0.2	1.8	16	430	1000
0.2	1.8	18	570	1000
0.2	1.8	20	750	1000
0.2	1.8	24	1050	1000
0.2	1.8	26	1330	1000

XLPE INSULATED, LSZH SHEATHED CABLES

COPPER CONDUCTOR STANDARD:IEC 60502-1

0.6/1 kV



CABLE CORE(S)

Nominal Area	No. of Wires	Approx. Conductor diameter	Nominal Insulation Thickness
mm ²	No.	mm	mm
3x 1.5re	1	1.38	0.7
3x 1.5rm	7	1.56	0.7
3x 2.5re	1	1.78	0.7
3x 2.5rm	7	2.01	0.7
3x 4 re	1	2.25	0.7
3x 4 rm	7	2.55	0.7
3x 6 re	1	2.76	0.7
3x 6 rm	7	3.12	0.7
3x 10rm	7	4.01	0.7
3x 16rm	7	5.03	0.7
3x 25sm	7	-	0.9
3x 35sm	7	-	0.9
3x 50sm	19	-	1.0
3x 70sm	19	-	1.1
3x 95sm	19	-	1.1
3x 120sm	37	-	1.2
3x 150sm	37	-	1.4
3x 185sm	37	-	1.6
3x 240sm	61	-	1.7
3x 300sm	61	-	1.8
3x 400sm	61	-	2.0
3x 500sm	61	-	2.2

UNARMoured

Nominal Sheath Thickness	Approx Overall diameter	Approx Weight	Standard Packing
mm	mm	Kg/Km	meters
1.8	13	200	1000
1.8	12	200	1000
1.8	13	250	1000
1.8	13	250	1000
1.8	14	325	1000
1.8	14	325	1000
1.8	15	400	1000
1.8	15	400	1000
1.8	18	525	1000
1.8	20	725	1000
1.8	24	1050	1000
1.8	26	1375	1000
1.8	28	1725	1000
1.9	32	2425	500
2.0	36	3250	500
2.1	40	4025	500
2.3	45	5000	500
2.4	50	6150	500
2.6	56	8025	500
2.8	61	9925	500
3.1	69	12600	250
3.3	78	16100	250

re: Round Solid
rm: Round Stranded
sm: Sectoral Stranded

Colour Code :
3 Cores : Red, Yellow, Blue

Tolerance Range:
Overall diameter ±5%
Packing ±5%

XLPE INSULATED, LSZH SHEATHED CABLES

COPPER CONDUCTOR STANDARD:IEC 60502-1

0.6/1 kV

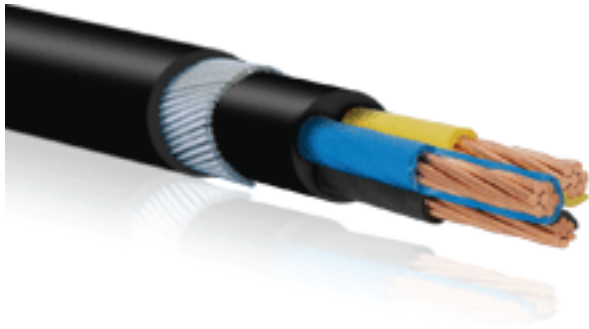

STEEL WIRE ARMoured

Steel Wire Diameter	Nominal Sheath Thickness	Approx. Overall diameter	Approx. Weight	Standard Packing
mm	mm	mm	Kg/Km	meters
-	-	-	-	-
0.8	1.8	14	350	-
-	-	-	-	-
0.8	1.8	15	400	-
-	-	-	-	-
0.8	1.8	16	490	1000
0.8	1.8	17	575	1000
0.8	1.8	17	590	1000
1.25	1.8	20	900	1000
1.25	1.8	22	1150	1000
1.6	1.8	25	1600	1000
1.6	1.8	27	1960	1000
1.6	1.9	30	2450	1000
2.0	2.0	35	3470	500
2.0	2.2	38	4400	500
2.0	2.3	41	5260	500
2.5	2.5	47	6770	500
2.5	2.6	51	8090	500
2.5	2.8	56	10120	500
2.5	3.0	62	12170	250
2.5	3.2	74	15725	250
3.15	3.5	85	20650	250

STEEL TAPE ARMoured

Steel Tape Thickness	Nominal Sheath Thickness	Approx. Overall diameter	Approx. Weight	Standard Packing
mm	mm	mm	Kg/Km	meters
-	-	-	-	-
0.2	1.8	13	260	-
-	-	-	-	-
0.2	1.8	14	325	-
-	-	-	-	-
0.2	1.8	15	380	1000
0.2	1.8	16	475	1000
0.2	1.8	17	470	1000
0.2	1.8	19	625	1000
0.2	1.8	21	840	1000
0.2	1.8	25	1200	1000
0.2	1.8	24	1430	1000
0.2	1.8	27	1850	1000
0.2	2.0	31	2550	500
0.2	2.1	35	3360	500
0.5	2.2	39	4480	500
0.5	2.4	44	5480	500
0.5	2.5	49	6690	500
0.5	2.7	53	8550	500
0.5	2.9	56	10460	250
0.5	3.1	66	13120	250
0.5	3.3	73	16540	250

XLPE INSULATED, LSZH SHEATHED CABLES

COPPER CONDUCTOR STANDARD:IEC 60502-1

0.6/1 kV



CABLE CORE(S)

Nominal Area	No. of Wires	Approx. Conductor diameter	Nominal Insulation Thickness
mm ²	No.	mm	mm
4 x 1.5re	1	1.38	0.7
4 x 1.5rm	7	1.56	0.7
4 x 2.5re	1	1.78	0.7
4 x 2.5rm	7	1.98	0.7
4 x 4 re	1	2.25	0.7
4 x 4 rm	7	2.52	0.7
4 x 6 re	1	2.76	0.7
4 x 6 rm	7	3.12	0.7
4 x 10rm	7	4.01	0.7
4 x 16rm	7	5.03	0.7
4 x 25sm	7	-	0.9
4 x 35sm	7	-	0.9
4 x 50sm	19	-	1.0
4 x 70sm	19	-	1.1
4 x 95sm	19	-	1.1
4 x 120sm	37	-	1.2
4 x 150sm	37	-	1.4
4 x 185sm	37	-	1.6
4 x 240sm	37	-	1.7
4 x 300sm	61	-	1.8
4 x 400sm	61	-	2.0
4 x 500sm	61	-	2.2

re: Round Solid
 rm: Round Stranded
 sm : Sectoral Stranded

UNARMoured

Nominal Sheath Thickness	Approx. Overall diameter	Approx. Weight	Standard Packing
mm	mm	Kg/Km	meters
1.8	13	225	1000
1.8	13	225	1000
1.8	14	300	1000
1.8	14	280	1000
1.8	15	375	1000
1.8	15	360	1000
1.8	17	475	1000
1.8	17	450	1000
1.8	19	640	1000
1.8	22	900	1000
1.8	24	1260	1000
1.8	26	1650	1000
1.9	30	2175	1000
2.0	34	3070	500
2.1	38	4090	500
2.3	43	5120	500
2.4	47	6280	500
2.6	52	7810	500
2.8	58	10140	250
3.0	64	12590	250
3.3	73	16060	250
3.5	80	20340	250

Colour Code :
 4 Cores : Red , Yellow , Blue , Black

Tolerance range:
 Overall diameter ±5%
 Packing ±5%

XLPE INSULATED, LSZH SHEATHED CABLES

COPPER CONDUCTOR STANDARD:IEC 60502-1

0.6/1 kV

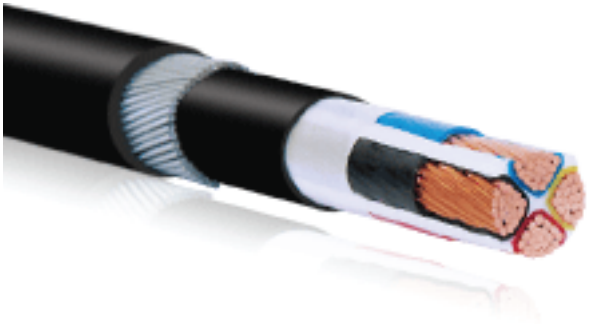

STEEL WIRE ARMoured

Steel Wire dia.	Nominal Sheath thickness	Approx. Overall diameter	Approx. Weight	Standard Packing
mm	mm	mm	Kg /Km	meters
-	-	-	-	-
0.8	1.8	15	400	1000
-	-	-	-	-
0.8	1.8	16	460	1000
-	-	-	-	-
0.8	1.8	17	560	1000
1.25	1.8	19	800	1000
1.25	1.8	19	810	1000
1.25	1.8	22	1050	1000
1.6	1.8	25	1525	1000
1.6	1.8	27	1930	1000
1.6	1.9	30	2400	1000
1.6	2.0	33	3030	1000
2.0	2.2	38	4330	500
2.0	2.3	42	5490	500
2.5	2.5	48	7075	500
2.5	2.6	52	8450	500
2.5	2.8	57	10200	250
2.5	3.0	63	12825	250
2.5	3.2	69	15530	250
3.15	3.5	79	20300	250
3.15	3.8	87	25025	250

STEEL TAPE ARMoured

Steel Tape Thickness	Nominal Sheath Thickness	Approx. Overall diameter	Approx. Weight	Standard Packing
mm	mm	mm	Kg/Km	meters
-	-	-	-	-
0.2	1.8	14	300	1000
-	-	-	-	-
0.2	1.8	15	360	1000
-	-	-	-	-
0.2	1.8	16	440	1000
0.2	1.8	17	550	1000
0.2	1.8	18	550	1000
0.2	1.8	20	750	1000
0.2	1.8	23	1025	1000
0.2	1.8	24	1400	1000
0.2	1.8	27	1800	1000
0.2	1.9	31	2360	1000
0.2	2.0	35	3270	500
0.5	2.2	40	4700	500
0.5	2.4	44	5790	500
0.5	2.5	49	7030	500
0.5	2.7	54	8040	500
0.5	2.9	60	11065	500
0.5	3.1	66	13600	250
0.5	3.4	75	17220	250
0.8	3.7	83	22420	250

XLPE INSULATED, LSZH SHEATHED CABLES

ALUMINIUM CONDUCTOR STANDARD:IEC 60502-1

0.6/1 kV



CABLE CORE(S)

Nominal Area	No. of wires	Approx. conductor diameter	Nominal Insulation Thickness
mm ²	No.	mm	mm
1 x 16rm	7	5.2	0.7
1 x 25rm	7	6.30	0.9
1 x 35rm	7	7.41	0.9
1 x 50rmc	7	8.30	1.0
1 x 70rmc	19	9.7	1.1
1 x 95rmc	19	11.5	1.1
1 x 120rmc	19	12.95	1.2
1 x 150rmc	19	14.3	1.4
1 x 185rmc	37	15.9	1.6
1 x 240rmc	37	18.4	1.7
1 x 300rmc	37	20.5	1.8
1 x 400rmc	37	24.0	2.0
1 x 500rmc	37	27.0	2.2
1 x 630rmc	61	30.4	2.4

CABLE CORE(S)

2 x 16rm	7	5.2	0.7
2 x 25rm	7	6.30	0.9
2 x 35rm	7	7.41	0.9

CABLE CORE(S)

3 x 16rm	7	5.2	0.7
3 x 25rm	7	6.30	0.9
3 x 35rm	7	7.41	0.9
3 x 50rmc	7	8.30	1.0
3 x 70rmc	19	9.7	1.1
3 x 95rmc	19	11.5	1.1
3 x 120rmc	19	12.95	1.2
3 x 150rmc	19	14.3	1.4
3 x 185rmc	37	15.9	1.6
3 x 240rmc	37	18.4	1.7
3 x 300rmc	37	20.5	1.8
3 x 400rmc	61	24.0	2.0
3 x 500rmc	61	27.0	2.2

re: Round Solid
 rm: Round Stranded
 rmc: Round Stranded Compacted

UNARMoured

Nominal Sheath Thickness	Approx. Overall Diameter	Approx. Weight	Standard Packing
mm	mm	Kg/Km	meter
1.4	10	115	1000
1.4	11	150	1000
1.4	12	200	1000
1.4	13	225	1000
1.4	15	300	1000
1.5	17	400	1000
1.5	18	475	1000
1.6	20	590	1000
1.6	22	715	1000
1.7	25	925	500
1.8	28	1125	500
1.9	32	1450	500
2.0	35	1820	500
2.2	42	2310	500

UNARMoured

1.8	19	460	1000
1.8	23	625	1000
1.8	25	760	1000

UNARMoured

1.8	21	450	1000
1.8	24	600	1000
1.8	26	740	1000
1.8	28	875	500
1.9	32	1175	500
2.0	37	1525	500
2.1	40	1835	500
2.3	45	2275	500
2.4	49	2765	250
2.6	56	3585	250
2.8	61	4325	250
3.1	70	5550	250
3.3	79	6990	250

Colour Code:
 1 Core: Black (Red on request)
 2 Cores: Red, Black
 3 Cores: Red, Yellow, Blue

Tolerance range :
 Overall diameter ± 5%
 Packing ± 5%

XLPE INSULATED, LSZH SHEATHED CABLES

ALUMINUM CONDUCTOR STANDARD:IEC 60502-1

0.6/1 kV

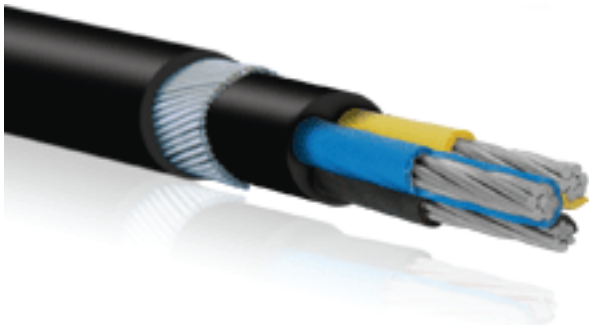

ALUMINIUM WIRE ARMoured

Nominal Alum / Steel Wire Diameter	Nominal Sheath Thickness	Approx. Overall diameter	Approx. Weight	Standard Packing
mm	mm	mm	Kg/Km	meters
0.8	1.8	14	250	1000
0.8	1.8	16	315	1000
0.8	1.8	17	370	1000
1.25	1.8	19	475	1000
1.25	1.8	21	560	500
1.25	1.8	22	680	500
1.6	1.8	24	835	500
1.6	1.8	26	970	500
1.6	1.8	28	1130	500
1.6	1.9	31	1390	500
1.6	1.9	33	1615	500
2.0	2.1	39	2150	500
2.0	2.2	42	2600	500
2.0	2.3	46	3160	500

ALUMINIUM TAPE ARMoured

Aluminium / Steel Tape Thickness	Nominal Sheath Thickness	Approx. Overall diameter	Approx. Weight	Standard Packing
mm	mm	mm	Kg/Km	meters
-	-	-	-	-
-	-	-	-	-
-	-	-	-	-
0.5	1.8	18	420	500
0.5	1.8	20	510	500
0.5	1.8	21	625	500
0.5	1.8	23	725	500
0.5	1.8	25	850	500
0.5	1.8	27	1000	500
0.5	1.8	29	1230	500
0.5	1.9	32	1460	500
0.5	2.0	37	1850	500
0.5	2.1	40	2270	500
0.5	2.3	44	2810	500

STEEL WIRE ARMoured

1.25	1.8	22	870	1000
1.6	1.8	26	1260	1000
1.6	1.8	28	1470	1000

STEEL TAPE ARMoured

0.2	1.8	20	570	1000
0.2	1.8	24	750	1000
0.2	1.8	26	910	500

STEEL WIRE ARMoured

1.25	1.8	23	880	1000
1.6	1.8	27	1275	1000
1.6	1.8	30	1475	500
1.6	1.9	-	1715	500
2.0	2.0	37	2360	500
2.0	2.2	-	3080	500
2.0	2.3	45	3340	500
2.5	2.5	50	4360	500
2.5	2.6	55	5060	250
2.5	2.8	61	6180	250
2.5	3.0	67	7180	250
2.5	3.2	76	8750	250
3.15	3.5	85	11550	250

STEEL TAPE ARMoured

0.2	1.8	21	560	1000
0.2	1.8	25	745	1000
0.2	1.8	27	900	500
0.2	1.8	28	1050	500
0.2	1.9	33	1370	500
0.2	2.1	35	1625	500
0.5	2.3	43	2480	500
0.5	2.5	47	2995	500
0.5	2.6	51	3560	500
0.5	2.8	58	4490	250
0.5	3.0	64	5320	250
0.5	3.3	72	6650	250
0.5	3.5	80	8200	250

XLPE INSULATED, LSZH SHEATHED CABLES

ALUMINIUM CONDUCTOR STANDARD: IEC 60502-1

0.6/1 kV

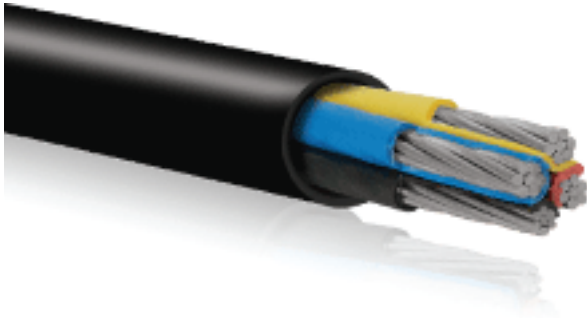

CABLE CORE(S)

Nominal Area	No. of Wires	Approx. Conductor diameter	Nominal Insulation Thickness
mm ²	No.	mm	mm
4 x 16rm	7	5.2	0.7
4 x 25rm	7	6.3	0.9
4 x 35sm	7	-	0.9
4 x 50sm	7	-	1.0
4 x 70sm	19	-	1.1
4 x 95sm	19	-	1.1
4 x 120sm	37	-	1.2
4 x 150sm	37	-	1.4
4 x 185sm	37	-	1.6
4 x 240sm	61	-	1.7
4 x 300sm	61	-	1.8
4 x 400sm	61	-	2.0
4 x 500sm	61	-	2.2

UNARMoured

Nominal Sheath Thickness	Approx. Overall diameter	Approx. Weight	Standard Packing
mm	mm	Kg/Km	meters
1.8	22	530	1000
1.8	26	725	1000
1.8	26	800	1000
1.9	30	1025	1000
2.0	34	1400	500
2.1	38	1775	500
2.3	42	2200	500
2.4	47	2650	500
2.6	52	3270	250
2.8	58	4200	250
3.0	63	5110	250
3.3	72	6535	250
3.5	80	8130	250

rm: Round Stranded
sm: Sectoral Stranded

Colour Code :
3½ Cores : Red, Yellow, Blue, Black
4 Cores: Red, Yellow, Blue, Black

Tolerance Range:
Overall diameter ±5%
Packing ±5%

XLPE INSULATED, LSZH SHEATHED CABLES

ALUMINIUM CONDUCTOR STANDARD:IEC 60502-1

0.6/1 kV



STEEL WIRE ARMoured

Steel Wire Diameter	Nominal Sheath Thickness	Approx. Overall diameter	Approx. Weight	Standard Packing
mm	mm	mm	Kg/Km	meters
1.6	1.8	26	1150	1000
1.6	1.8	29	1475	500
1.6	1.9	30	1550	500
1.6	2.0	33	1875	500
2.0	2.2	38	2650	500
2.0	2.3	42	3175	500
2.5	2.5	48	4150	500
2.5	2.6	52	4825	500
2.5	2.8	57	5650	250
2.5	3.0	63	6890	250
2.5	3.2	69	8050	250
3.15	3.5	79	10775	250
3.15	3.8	87	12810	250

STEEL TAPE ARMoured

Steel Tape Thickness	Nominal Sheath Thickness	Approx. Overall diameter	Approx. Weight	Standard Packing
mm	mm	mm	Kg/Km	meters
0.2	1.8	23	660	1000
0.2	1.8	27	880	500
0.2	1.8	27	960	500
0.2	1.9	30	1020	500
0.2	2.0	35	1600	500
0.5	2.2	40	2380	500
0.5	2.4	44	2880	250
0.5	2.5	49	3400	250
0.5	2.7	53	4100	250
0.5	2.9	60	5130	250
0.5	3.1	66	6130	250
0.5	3.4	75	7700	250
0.8	3.7	84	10210	250

XLPE INSULATED, LSZH SHEATHED CABLES

COPPER CONDUCTOR STANDARD:BS 6724

0.6/1 kV



ALUMINIUM WIRE ARMoured CABLES

Nominal Area	No. of Wires	Approx. Conductor Diameter	Nominal Insulation Thickness	Nominal Alum / Steel Wire Diameter	Nominal Sheath Thickness	Approx. Overall Diameter	Approx. Weight	Standard Packing
mm ²	no.	mm	mm	mm	mm	mm	Kg/Km	mm
1 x 50rmc	19	8.1	1.0	0.9	1.5	17	675	1000
1 x 70rmc	19	9.7	1.1	1.25	1.5	20	925	1000
1 x 95rmc	19	11.4	1.1	1.25	1.6	22	1200	1000
1 x 120rmc	37	12.9	1.2	1.25	1.6	24	1450	1000
1 x 150rmc	37	14.3	1.4	1.6	1.7	27	1850	1000
1 x 185rmc	37	16.0	1.6	1.6	1.8	30	2250	1000
1 x 240rmc	61	18.4	1.7	1.6	1.8	33	2850	1000
1 x 300rmc	61	20.4	1.8	1.6	1.9	36	3475	500
1 x 400rmc	61	23.2	2.0	2.0	2.0	41	4450	500
1 x 500rmc	61	26.7	2.2	2.0	2.1	44	5575	500
1 x 630rmc	61	30.4	2.4	2.0	2.2	49	7050	500
1 x 800rmc	61	33.7	2.6	2.5	2.4	55	9050	500
1 x 1000rm	91	41.0	2.8	2.5	2.5	61	11500	500

STEEL WIRE ARMoured CABLES

2 x 1.5rm	7	1.56	0.6	0.9	1.3	12	275	1000
2 x 2.5rm	7	2.01	0.7	0.9	1.4	14	350	1000
2 x 4rm	7	2.55	0.7	0.9	1.4	15	425	1000
2 x 6rm	7	3.12	0.7	0.9	1.4	16	500	1000
2 x 10rm	7	4.01	0.7	0.9	1.5	18	650	1000
2 x 16rm	7	5.03	0.7	1.25	1.5	20	975	1000
2 x 25sm	7	-	0.9	1.25	1.6	24	1350	1000
2 x 35sm	7	-	0.9	1.6	1.7	27	1850	1000

rm: Round Stranded
rmc: Round Stranded Compacted
sm: Sectoral Stranded

Standard Colour Code:

1 Core : Black (Red on request)
2 Cores : Red, Black

Color code based on special request

1 Core: Brown or Blue
2 Cores: Brown, Blue

XLPE INSULATED, LSZH SHEATHED CABLES

COPPER CONDUCTOR STANDARD:BS 6724

0.6/1 kV

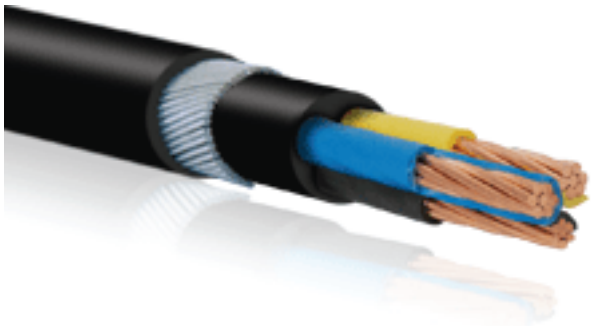

STEEL WIRE ARMoured CABLES

Nominal Area	No. of Wires	Approx. Conductor Diameter	Nominal Insulation Thickness	Nominal Alum / Steel Wire Diameter	Nominal Sheath Thickness	Approx. Overall Diameter	Approx. Weight	Standard Packing
mm ²	No.	mm	mm	mm	mm	mm	Kg/Km	mm
3 x 1.5rm	7	1.56	0.6	0.9	1.3	13	300	1000
3 x 2.5rm	7	2.01	0.7	0.9	1.4	14	400	1000
3 x 4 rm	7	2.55	0.7	0.9	1.4	15	475	1000
3 x 6rm	7	3.12	0.7	0.9	1.4	17	575	1000
3 x 10rm	7	4.02	0.7	1.25	1.5	20	850	1000
3 x 16rm	7	5.03	0.7	1.25	1.6	22	1100	1000
3 x 25sm	7	-	0.9	1.6	1.7	24	1590	1000
3 x 35sm	7	-	0.9	1.6	1.8	26	1965	1000
3 x 50 sm	19	-	1.0	1.6	1.8	29	2440	1000
3 x 70sm	19	-	1.1	1.6	1.9	32	3200	500
3 x 95sm	19	-	1.1	2.0	2.1	37	4390	500
3 x 120sm	37	-	1.2	2.0	2.2	40	5250	500
3 x 150sm	37	-	1.4	2.5	2.3	46	6740	500
3 x 185sm	37	-	1.6	2.5	2.4	50	8050	250
3 x 240sm	61	-	1.7	2.5	2.6	55	9990	250
3 x 300sm	61	-	1.8	2.5	2.7	60	12100	250
3 x 400sm	61	-	2.0	2.5	2.9	67	14970	250

rm: Round Stranded
sm: Sectoral Stranded

Standard Colour Code:
 3 Core : Red, Yellow, Blue

Color code based on special request
 3 Cores: Brown, Black, Grey

XLPE INSULATED, LSZH SHEATHED CABLES

COPPER CONDUCTOR STANDARD:BS 6724

0.6/1 kV

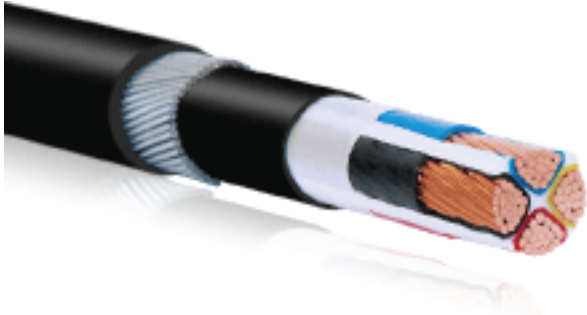

STEEL WIRE ARMoured CABLES

Nominal Area	No. of Wires	Approx. Conductor Diameter	Nominal Insulation Thickness	Nominal Steel Wire Diameter	Nominal Sheath Thickness	Approx. Overall Diameter	Approx. Weight	Standard Packing
mm ²	No.	mm	mm	mm	mm	mm	Kg /Km	mm
4 x 1.5rm	7	1.56	0.6	0.9	1.3	13	350	1000
4 x 2.5rm	7	2.01	0.7	0.9	1.4	15	450	1000
4 x 4 rm	7	2.55	0.7	0.9	1.4	16	550	1000
4 x 6rm	7	3.12	0.7	1.25	1.5	19	750	1000
4 x 10rm	7	4.01	0.7	1.25	1.5	21	1000	1000
4 x 16rm	7	5.03	0.7	1.25	1.6	23	1325	1000
4 x 25sm	7	-	0.9	1.6	1.7	26	1925	1000
4 x 35sm	7	-	0.9	1.6	1.8	29	2390	1000
4 x 50sm	19	-	1.0	1.6	1.9	32	3015	1000
4 x 70sm	19	-	1.1	2.0	2.1	38	4300	500
4 x 95sm	19	-	1.1	2.0	2.2	42	5480	500
4 x 120sm	37	-	1.2	2.5	2.3	47	7035	500
4 x 150sm	37	-	1.4	2.5	2.4	52	8410	500
4 x 185sm	37	-	1.6	2.5	2.6	57	10125	250
4 x 240sm	37	-	1.7	2.5	2.7	63	12725	250
4 x 300sm	61	-	1.8	2.5	2.9	69	15400	250
4 x 400sm	61	-	2.0	3.15	3.2	78	20175	250

STEEL WIRE ARMoured CABLES

5 x 1.5rm	7	1.56	0.6	0.9	1.4	14	400	1000
5 x 2.5rm	7	2.01	0.7	0.9	1.4	16	515	1000
5 x 4 rm	7	2.55	0.7	0.9	1.5	18	650	1000
5 x 6rm	7	3.12	0.7	1.25	1.5	20	900	1000
5 x 10rm	7	4.01	0.7	1.25	1.6	23	1190	1000
5 x 16rm	7	5.03	0.7	1.6	1.7	27	1750	1000
5 x 25rm	7	6.3	0.9	1.6	1.8	31	2450	1000
5 x 35rm	7	7.44	0.9	1.6	1.9	34	3075	500
5 x 50rmc	19	8.1	1.0	2.0	2.0	40	4040	500
5 x 70rmc	19	9.7	1.1	2.0	2.2	46	5350	500

rm: Round Stranded

rmc: Round Stranded Compacted

sm: Sectoral Stranded

Standard Colour Code:

4 Cores: Red, Yellow, Blue, Black

5 Cores: Red, Yellow, Blue, Black, Green/Yellow

Colorcode based on special request

4 Cores: Blue, Brown, Black, Grey

5 Cores: Green/Yellow Blue, Brown, Black, Grey

ELECTRICAL PARAMETERS 0.6/1 kV

LOW VOLTAGE SINGLE CORE CABLE (IN TREFOIL FORMATION)

LINEAR RESISTANCE, REACTANCE AND VOLTAGE DROP OF PVC INSULATED (70°C) COPPER CONDUCTOR AT 50 HERTZ

SIZE MM ²	R (DC) 20°C	R (DC) 70°C	R (AC) 70°C	X	Z	VD
1.5	12.1	14.47	14.47	0.197	14.47	20.25
2.5	7.41	8.86	8.86	0.186	8.86	12.47
4	4.61	5.51	5.51	0.171	5.51	7.81
6	3.08	3.68	3.68	0.162	3.68	5.27
10	1.83	2.19	2.19	0.151	2.19	3.19
16	1.15	1.37	1.37	0.140	1.38	2.04
25	0.727	0.87	0.87	0.130	0.86	1.34
35	0.524	0.627	0.627	0.123	0.64	1.00
50	0.387	0.46	0.46	0.118	0.47	0.76
70	0.268	0.321	0.321	0.112	0.34	0.56
95	0.193	0.231	0.231	0.108	0.25	0.43
120	0.153	0.183	0.184	0.104	0.21	0.36
150	0.124	0.148	0.149	0.102	0.18	0.31
185	0.0991	0.118	0.12	0.100	0.16	0.27
240	0.0754	0.0902	0.092	0.096	0.13	0.23
300	0.0601	0.0719	0.0746	0.094	0.12	0.20
400	0.0470	0.056	0.059	0.092	0.11	0.18
500	0.0366	0.043	0.0483	0.090	0.10	0.16
630	0.0283	0.033	0.039	0.087	0.10	0.14

R (DC) 20°C : DIRECT CURRENT RESISTANCE AT 20°C, Ohm / Km

R (DC) 70°C : DIRECT CURRENT RESISTANCE AT 70°C, Ohm / Km

R (AC) 70°C : ALTERNATING CURRENT RESISTANCE AT 70°C, Ohm / Km

X : REACTANCE , Ohm / Km

Z : IMPEDANCE , Ohm / Km

VD : VOLTAGE DROP, V / Amp. Km (Phase to Phase)

ELECTRICAL PARAMETERS 0.6/1 kV

LOW VOLTAGE CABLE (MULTI CORE)

LINEAR RESISTANCE, REACTANCE AND VOLTAGE DROP OF PVC INSULATED (70°C) COPPER CONDUCTOR AT 50 HERTZ

SIZE MM ²	R (DC) 20°C	R (DC) 70°C	R (AC) 70°C	X	Z	VD
1.5	12.1	14.47	14.47	0.110	14.47	20.16
2.5	7.41	8.86	8.86	0.103	8.86	12.38
4	4.61	5.51	5.51	0.102	5.51	7.74
6	3.08	3.68	3.68	0.097	3.68	5.20
10	1.83	2.19	2.19	0.091	2.19	3.13
16	1.15	1.37	1.37	0.086	1.37	1.99
25	0.727	0.869	0.870	0.086	0.87	1.29
35	0.524	0.627	0.627	0.083	0.63	0.95
50	0.387	0.463	0.463	0.081	0.47	0.73
70	0.268	0.320	0.321	0.078	0.33	0.53
95	0.193	0.230	0.232	0.078	0.24	0.40
120	0.153	0.183	0.184	0.076	0.20	0.33
150	0.124	0.148	0.150	0.076	0.17	0.29
185	0.0991	0.118	0.121	0.076	0.14	0.25
240	0.0754	0.090	0.094	0.074	0.12	0.21
300	0.0601	0.071	0.076	0.074	0.11	0.18
400	0.047	0.056	0.062	0.074	0.10	0.16
500	0.0366	0.044	0.051	0.073	0.09	0.15
630	0.0283	0.033	0.042	0.072	0.08	0.13

R (DC) 20°C : DIRECT CURRENT RESISTANCE AT 20°C, Ohm / Km

R (DC) 70°C : DIRECT CURRENT RESISTANCE AT 70°C, Ohm / Km

R (AC) 70°C : ALTERNATING CURRENT RESISTANCE AT 70°C, Ohm / Km

X : REACTANCE, Ohm / Km

Z : IMPEDANCE, Ohm / Km

VD : VOLTAGE DROP, V / Amp. Km (Phase to Phase)

ELECTRICAL PARAMETERS 0.6/1 kV

LOW VOLTAGE SINGLE CORE CABLE (IN TREFOIL FORMATION)

LINEAR RESISTANCE, REACTANCE AND VOLTAGE DROP OF XLPE INSULATED (90°C) COPPER CONDUCTOR AT 50 HERTZ

SIZE MM ²	R (DC) 20°C	R (DC) 90°C	R (AC) 90°C	X	Z	VD
1.5	12.1	15.42	15.42	0.181	15.42	21.55
2.5	7.41	9.44	9.44	0.171	9.44	13.26
4	4.61	5.870	5.870	0.156	5.87	8.30
6	3.08	3.92	3.92	0.148	3.92	5.59
10	1.83	2.330	2.330	0.138	2.336	3.37
16	1.15	1.466	1.466	0.136	1.47	2.17
25	0.727	0.927	0.927	0.126	0.94	1.42
35	0.524	0.668	0.668	0.119	0.68	1.05
50	0.387	0.493	0.493	0.115	0.51	0.80
70	0.268	0.34	0.342	0.110	0.36	0.59
95	0.193	0.246	0.246	0.102	0.27	0.45
120	0.153	0.195	0.196	0.099	0.22	0.37
150	0.124	0.158	0.159	0.098	0.19	0.32
185	0.0991	0.126	0.128	0.095	0.16	0.28
240	0.0754	0.096	0.098	0.093	0.13	0.23
300	0.0601	0.076	0.079	0.090	0.12	0.20
400	0.047	0.060	0.063	0.091	0.11	0.18
500	0.0366	0.046	0.051	0.088	0.10	0.16
630	0.0283	0.036	0.042	0.086	0.10	0.15

- R (DC) 20°C :** DIRECT CURRENT RESISTANCE AT 20°C, Ohm / Km
R (DC) 90°C : DIRECT CURRENT RESISTANCE AT 90°C, Ohm / Km
R (AC) 90°C : ALTERNATING CURRENT RESISTANCE AT 90°C, Ohm / Km
X : REACTANCE, Ohm / Km
Z : IMPEDANCE, Ohm / Km
VD : DROP, V / Amp. Km (Phase to Phase)

XLPE INSULATED, LSZH SHEATHED CABLES

LOW VOLTAGE CABLE (MULTI CORE)

LINEAR RESISTANCE, REACTANCE AND VOLTAGE DROP OF XLPE INSULATED (90°C) COPPER CONDUCTOR AT 50 HERTZ

SIZE MM ²	R (DC) 20°C	R (DC) 90°C	R (AC) 90°C	X	Z	VD
1.5	12.1	15.42	15.42	0.106	15.42	21.48
2.5	7.41	9.44	9.44	0.099	9.4	13.18
4	4.61	5.870	5.870	0.093	5.87	8.23
6	3.08	3.920	3.920	0.089	3.92	5.52
10	1.83	2.330	2.330	0.084	2.33	3.32
16	1.15	1.466	1.466	0.081	1.47	2.12
25	0.727	0.927	0.927	0.081	0.93	1.37
35	0.524	0.668	0.668	0.079	0.67	1.01
50	0.387	0.493	0.494	0.076	0.50	0.76
70	0.268	0.341	0.342	0.075	0.35	0.55
95	0.193	0.246	0.247	0.074	0.26	0.42
120	0.153	0.195	0.196	0.072	0.21	0.35
150	0.124	0.158	0.160	0.073	0.18	0.30
185	0.0991	0.126	0.13	0.073	0.15	0.25
240	0.0754	0.096	0.099	0.072	0.12	0.21
300	0.0601	0.076	0.081	0.071	0.11	0.19
400	0.047	0.060	0.065	0.071	0.10	0.16
500	0.0366	0.046	0.053	0.071	0.09	0.15
630	0.0283	0.036	0.044	0.070	0.08	0.13

- R (DC) 20°C :** DIRECT CURRENT RESISTANCE AT 20°C, Ohm / Km
R (DC) 90°C : DIRECT CURRENT RESISTANCE AT 90°C, Ohm / Km
R (AC) 90°C : ALTERNATING CURRENT RESISTANCE AT 90°C, Ohm / Km
X : REACTANCE, Ohm / Km
Z : IMPEDANCE, Ohm / Km
VD : VOLTAGE DROP, V / Amp. Km (Phase to Phase)

XLPE INSULATED, LSZH SHEATHED CABLES

LOW VOLTAGE SINGLE CORE CABLE (IN TREFOIL FORMATION)

LINEAR RESISTANCE, REACTANCE AND VOLTAGE DROP OF XLPE INSULATED (90°C) ALUMINIUM CONDUCTOR AT 50 HERTZ

SIZE MM ²	R (DC) 20°C	R (DC) 90°C	R (AC) 90°C	X	Z	VD
16	1.91	2.45	2.45	0.1048	2.45	3.48
25	1.20	1.539	1.539	0.0987	1.53	2.22
35	0.868	1.106	1.106	0.094	1.11	1.63
50	0.641	0.817	0.817	0.092	0.82	1.23
70	0.443	0.564	0.565	0.088	0.57	0.87
95	0.320	0.408	0.408	0.088	0.42	0.66
120	0.253	0.323	0.323	0.0842	0.33	0.54
150	0.206	0.262	0.263	0.0812	0.28	0.45
185	0.164	0.209	0.21	0.083	0.23	0.38
240	0.125	0.159	0.161	0.079	0.18	0.31
300	0.100	0.127	0.129	0.079	0.152	0.26
400	0.0778	0.0992	0.102	0.078	0.13	0.22
500	0.0605	0.0771	0.0809	0.076	0.11	0.19
630	0.0469	0.059	0.0643	0.077	0.10	0.17

LOW VOLTAGE CABLE (MULTI CORE)

LINEAR RESISTANCE, REACTANCE AND VOLTAGE DROP OF XLPE INSULATED (90°C) ALUMINIUM CONDUCTOR AT 50 HERTZ

SIZE MM ²	R (DC) 20°C	R (DC) 90°C	R (AC) 90°C	X	Z	VD
16	1.91	2.44	2.44	0.079	2.44	3.46
25	1.20	1.53	1.53	0.081	1.53	2.20
35	0.868	1.106	1.106	0.079	1.11	1.61
50	0.641	0.817	0.817	0.076	0.82	1.21
70	0.443	0.564	0.564	0.075	0.57	0.86
95	0.320	0.408	0.408	0.073	0.41	0.64
120	0.253	0.322	0.323	0.072	0.33	0.52
150	0.206	0.262	0.263	0.072	0.27	0.44
185	0.164	0.209	0.210	0.073	0.22	0.37
240	0.125	0.159	0.161	0.072	0.18	0.30
300	0.100	0.127	0.13	0.071	0.15	0.25
400	0.0778	0.099	0.102	0.070	0.12	0.21
500	0.0605	0.077	0.0816	0.071	0.11	0.19
630	0.0469	0.059	0.065	0.070	0.10	0.16

R (DC) 20: Direct Current Resistance at 20°C, Ohm / Km

R (DC) 90: Direct Current Resistance at 90°C, Ohm / Km

X : Reactance, Ohm / Km

Z : Impedance, Ohm / Km

PVC INSULATION

STANDARD: BS 7655, IEC 60502-1

PARTICULARS & GUARANTEES RELATING TO PVC INSULATING COMPOUND (TYPE T11)

SL NO.	DESCRIPTION	UNIT	GUARANTEED PARTICULARS
1	Tensile Strength and Elongation at break: Min. tensile strength Min. elongation at break	N/mm ² %	12.5 125
2	Low temperature bend test: Temperature at which specimen shall not track	°C	-15 ± 2
3	Low temperature elongation test: Test temperature Min. Elongation	°C %	-15 ± 2 30
4	Low temperature impact test: Temperature at which specimen Shall not crack	°C	-15 ± 2
5	Accelerated ageing for specified Period at specified temperature Followed by loss of mass test: Max. loss of mass, after ageing for 7 days at 80 ± 2 °C	Mg/cm ²	2.0
6	Accelerated ageing for specified period at specified temperature Followed by tensile strength & Elongation at break Number of days ageing Ageing temperature Tensile Strength after ageing: Min. value Max. variation Elongation at break after ageing: Min. value Max. variation from unaged value	Days °C N/mm ² % % %	7 80 ± 2 12.5 20 125 20
7	Pressure test at high temperature: Test temperature Max. indentation	°C %	80 ± 2 50
8	Resistance to cracking: Temperature at which specimen Shall not crack	°C	150 ± 2
9	Insulation resistance constant: Min. K. value at 70°C	M.Ω.km	0.037

PARTICULARS & GUARANTEES RELATING TO PVC INSULATING COMPOUND (TYPE A)

SL NO.	DESCRIPTION	UNIT	GUARANTEED PARTICULARS
1	Tensile Strength and Elongation at break: Min. tensile strength Min. elongation at break	N/mm ² %	12.5 125
2	Low temperature bend test: Temperature at which specimen shall not track	°C	-15 ± 2
3	Low temperature elongation test: Test temperature Min. Elongation	°C %	-15 ± 2 30
4	Low temperature impact test: Temperature at which specimen Shall not crack	°C	-
5	Accelerated ageing for specified Period at specified temperature Followed by loss of mass test: Max. loss of mass, after ageing for 7 days at 80 ± 2 °C	Mg/cm ²	-
6	Accelerated ageing for specified period at specified temperature Followed by tensile strength & Elongation at break Number of days ageing Ageing temperature Tensile Strength after ageing: Min. value Max. variation Elongation at break after ageing: Min. value Max. variation from unaged value	Days °C N/mm ² % % %	7 100 ± 2 12.5 25 150 25
7	Pressure test at high temperature: Test temperature Max. indentation	°C %	80 ± 2 50
8	Resistance to cracking: Temperature at which specimen Shall not crack	°C	150 ± 2
9	Water Absorption Temperature Duration, Max. variation of mass	°C Days mg/cm ²	70 ± 2 10 1

PVC OUTER SHEATH

STANDARD: BS 7655, IEC 60502-1

PARTICULARS & GUARANTEES RELATING TO PVC INSULATING COMPOUND (TYPE 5)

SL NO.	DESCRIPTION	UNIT	GUARANTEED PARTICULARS
1	Tensile Strength and Elongation at break: Min. tensile strength Min. elongation at break	N/mm ² %	12.5 125
2	Low temperature bend test: Temperature at which specimen shall not track	°C	-15 ± 2
3	Low temperature elongation test: Test temperature Min. Elongation	°C %	-15 ± 2 30
4	Accelerated ageing for specified at specified temperature followed by loss of mass test: Max. loss of mass, after ageing 10 days at 115 ± 2 °C	Mg/cm ²	1.5
5	Accelerated ageing for specified period at specified temperature Followed by tensile strength & Elongation at break Number of days ageing Ageing temperature Tensile Strength after ageing: Min. value Max. variation Elongation at break after ageing: Min. value Max. variation from unaged value	Days °C N/mm ² % % %	10 135 ± 2 12.5 25 125 25
6	Pressure test at high temperature: Test temperature Max. indentation	°C %	95 ± 2 50
7	Resistance to cracking: Temperature at which specimen Shall not crack	°C	150 ± 2
8	Insulation resistance constant: Min. K. value at 70°C	M.Ω.km	180

PARTICULARS & GUARANTEES RELATING TO XLPE INSULATION

SL NO.	DESCRIPTION	UNIT	GUARANTEED PARTICULARS
1	Tensile Strength and Elongation at break: Min. tensile strength Min. elongation at break	N/mm ² %	12.5 200
2	Accelerated ageing for specified period at specified temperature Followed by tensile strength & Elongation at break Number of days ageing Ageing temperature Max. variation of textile strength From unaged specimen Max. variation of elongation from unaged specimen	Days °C % %	7 135 ± 2 ± 25 ± 25
3	Hot Set Test: Treatment: -Temperature -Time under load -Mechanical stress Max. elongation under load Max permanent elongation after Cooling	°C Minutes N/mm ² % %	200 ± 3 15 20 175 15
4	Water Absorption: Treatment: -Temperature -Duration Max. variation of mass	°C Days mg/cm ²	85 ± 2 14 1.0
5	Maximum permissible shrinkage: Treatment: -Temperature -Duration Maximum permissible shrinkage	°C Hours %	130 ± 2 14
6	Insulation Resistance constant (Ki) at maximum rated temperature (90 °C)	M.Ω.km	3.67
7	Volume Resistivity at maximum rated temperature (90 °C)	Ω.cm	10 ¹²

PVC OUTER SHEATH

STANDARD: IEC 60502-1, BS 7655

PARTICULARS & GUARANTEES RELATING TO PVC
OUTER SHEATH TYPE ST2 (IEC 60502), TYPE 9 (BS 7655)

SL NO.	DESCRIPTION	UNIT	GUARANTEED PARTICULARS
1	Tensile Strength and Elongation at break: Min. tensile strength Min. elongation at break	N/mm ² %	12.5 150
2	Low temperature bend test: Temperature at which specimen shall not track	°C	-15 ± 2
3	Low temperature elongation test: Test temperature Min. Elongation	°C %	-15 ± 2 20
4	Low temperature impact test: Temperature at which specimen shall not crack	°C	-15 ± 2
5	Loss of mass: After ageing for 7 days at 100 ± 2 °C Max. loss of mass	mg/cm ²	1.5
6	Properties after ageing for specified period at specified temperature followed by tensile strength and elongation at break test. Number of days ageing Ageing temperature Tensile Strength after ageing: Minimum value Maximum variation Elongation at break after ageing: Minimum value Maximum variation from un-aged value	Days °C N/mm ² % % %	7 100 ± 2 12.5 25 150 25
7	Pressure test at high temperature: Test temperature Max. indentation	°C %	90 ± 2 50
8	Heat Shock Test: Temperature at which specimen shall not crack	°C %	150 ± 2
9	Insulation resistance constant: Min. K. value at 20°C	M.Ohm.km	0.0035
9	Flame Retardancy test (if required)	As per IEC 60332-1 (upon request)	

LSZH OUTER SHEATH

STANDARD: IEC 60502-1

600/1000 VOLTS

PARTICULARS & GUARANTEES RELATING TO
LSZH OUTER SHEATH TYPE ST8 (IEC 60502-1)

SL NO.	DESCRIPTION	UNIT	GUARANTEED PARTICULARS
1	Tensile Strength and Elongation at break: Minimum Tensile Strength Minimum Elongation at break	N/mm ² %	9 125v
2	Properties after ageing for specified period at specified temperature followed by tensile strength and elongation at break test. Number of days ageing Ageing temperature Tensile Strength after ageing: Minimum value Maximum variation Elongation at break after ageing: Minimum value Maximum variation from un-aged value	Days °C N/mm ² % % %	7 100 ± 2 9 40 100 40
3	Low temperature bend test: Test temperature at which specimen shall not crack	°C	-15 ± 2
4	Low temperature elongation test: Test temperature Minimum Elongation	°C %	-15 ± 2 20
5	Low temperature impact test: Temperature at which specimen shall not crack	°C	-15 ± 2
6	Pressure test at high temperature: Test temperature Maximum indentation	°C %	80 ± 2 50
7	Water Absorption: Ageing: Number of hours Ageing temperature Maximum increase in Mass	hours °C mg/cm ²	24 70 ± 2 10
8	Acidic emission and corrosive gases evolved Level of HCl Fluorine Content pH Minimum Conductivity	% % μS/mm	<0.5 <0.1 4.3 10

LSZH OUTER SHEATH

STANDARD: BS 6724, BS 7655

600/1000 VOLTS

PARTICULARS & GUARANTEES RELATING TO
LSZH OUTER SHEATH TYPE LTS1 (BS 7655)

SL NO.	DESCRIPTION	UNIT	GUARANTEED PARTICULARS
1	Tensile Strength and Elongation at break: Minimum Tensile Strength Minimum Elongation at break	N/mm ² %	10 100
2	Properties after ageing for specified period at specified temperature followed by tensile strength and elongation at break test. Number of days ageing Ageing temperature Tensile Strength after ageing: Minimum value Maximum variation Elongation at break after ageing: Minimum value Maximum variation from un-aged value	Days °C N/mm ² % % %	7 100 ± 2 10 40 100 40
3	Low temperature bend test: Test temperature at which specimen shall not crack	°C	-15 ± 2
4	Low temperature elongation test: Test temperature Minimum Elongation	°C %	-15 ± 2 30
5	Low temperature impact test: Temperature at which specimen shall not crack	°C	-15 ± 2
6	Pressure test at high temperature: Test temperature Maximum indentation	°C %	80 ± 2 50
7	Tear Resistance Test as per BS 6469 (Sec. 99.1) Minimum value	N/mm	5
8	Water Immersion Test as per BS 6469 (Sec. 99.1) Ageing: Number of days Ageing temperature Maximum variation in tensile strength Maximum variation in elongation at break	Days °C % %	7 70 ± 2 30 30
9	Acidic emission and corrosive gases evolved Level of HCL	%	<0.5

GUIDELINES FOR THE SELECTION OF THE REQUIRED SIZE OF CABLE

The required sizes of cable shall be selected based on the following steps:

Ampacity: Based on the required ampacity and the installation condition, a suitable size of cable can be selected.

Voltage Drop: The suitability of the above selected size shall be cross checked with the voltage drop. If it is within the limit, the selection is ok. Otherwise, the higher size (whose voltage drop suits the requirement) shall be selected. Following is an example for the above:

Example:

150 meters of three core cable, XLPE insulated, PVC sheathed, copper cable installed under ground to carry 100 amperes load, supply voltage 380 V.three phase system 50Hz, Ground temperature 40°C, soil thermal resistivity 2.5 k.m. / W and load factor 1.

Derating Factors:

*35mm² cable ampacity = 176 amps

*Soil thermal resistivity = 0.71

*Ground temperature = 0.85

Therefore derated current = 106 Amps (176 x 0.71 x 0.85)

Voltage drop(V_{ap}) =
$$\frac{V_p \times 1000 \times V \text{ V/A/KM}}{I \times L \times 100}$$

V_p = maximum permissible voltage drop (say2.5%)

V = System voltage (Here 380V)

L = Length in meters (Here 150 meter)

Therefore, V_{ap} =
$$\frac{2.5 \times 1000 \times 380 \text{ V/A/KM}}{100 \times 150 \times 100}$$

= 0.633V/A/KM

From table on page 52 of this catalogue, the voltage drop of 35 mm² XLPE insulated multi core cable is 1.011 V/A/km, which is much higher than the requirement of 0.633 V/A/km. The voltage drop of 70 mm² cable is 0.556 V/A/km which is with in the limit. Therefore, the suitable size is 70 mm².

DRUM HANDLING INSTRUCTIONS

Cables and Conductors should be installed by trained personnel in accordance with good engineering practices, recognized codes of practice, statutory local requirements, IEE wiring regulations and where relevant, in accordance with any specific instructions issued by the company. Cables are often supplied in heavy cable reels and handling these reels can constitute a safety hazard. In particular, dangers may arise during the removal of steel binding straps and during the removal of retaining battens and timbers which may expose projecting nails.

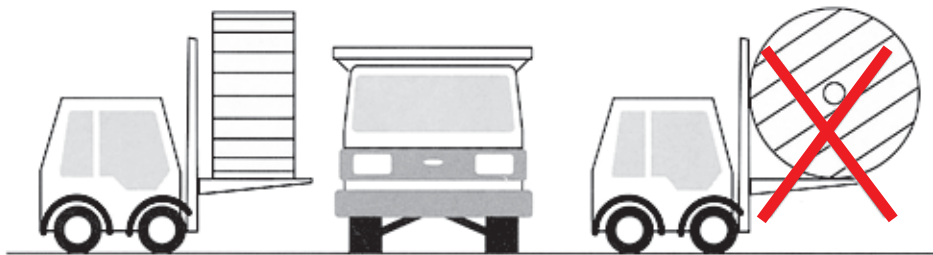
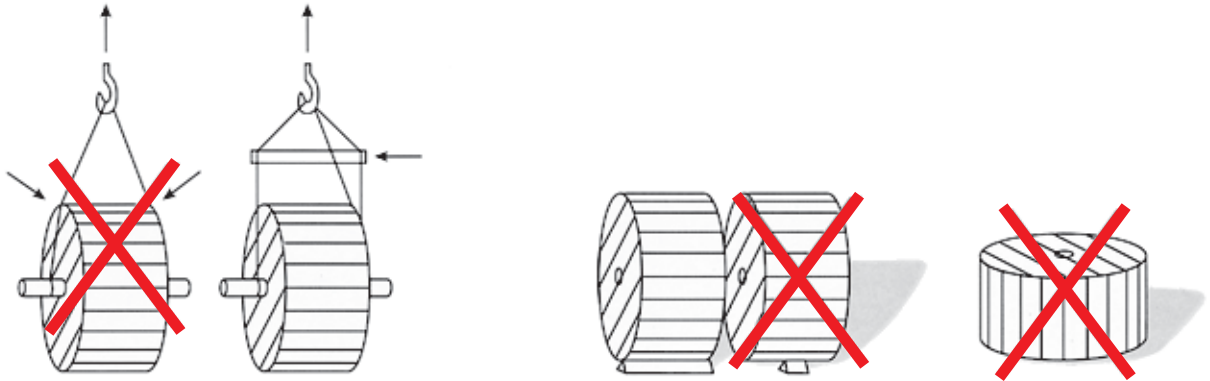



Mark Cables FZE

S40202A- Street S900

Jebel Ali Free Zone South

P.O.Box 17371, Dubai, UAE

Tel: +971 4 881 9616, Fax: +971 4 881 9636

Email: sales@markcables.com

www.markcables.com